

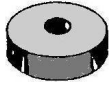















INDIVIDUAL PARTS / FAUCET REPAIRS

Contents of Chapter 1:

Bibb Washers		1-02
Bibb Screws		1-04
Friction Rings		1-06
Stem, Bonnet & Cap Gaskets		1-08
O-Rings		1-13
Vacuum Breakers & Mix Valves		1-17
Balancing Spools		1-17
Faucet Seats		1-18
Aerators & Sprays		1-24
Faucet Diverters		1-29
Aqua-Pure™ Filters		1-30
Kitchen Spouts		1-33
Faucet Handles		1-38
Index Buttons		1-64
Escutcheons & Trim Kits		1-69
Jiffy™ Kits		1-73
Plastic Cartridge Mini Guide		1-80

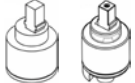

INDIVIDUAL PARTS / FAUCET REPAIRS

CREST/GOOD'S EXCLUSIVE BUNA-N HEAT-PRUF™ FAUCET WASHERS

BUNA-N is the same compound as is used in airplane tires -- You know they've got to be tough! For over 7 decades, **Crest/Good's BUNA-N Heat-Pruf™ washers** have proved "call-back" proof by plumbers, because of the unique compound used in their manufacture. The exclusive shallow design of the "Fulflo" beveled washers does not restrict water flow, even on quarter turn faucets. These washers will not distort or crack when the bibb screw is tightened.



FLAT

FUL-FLO

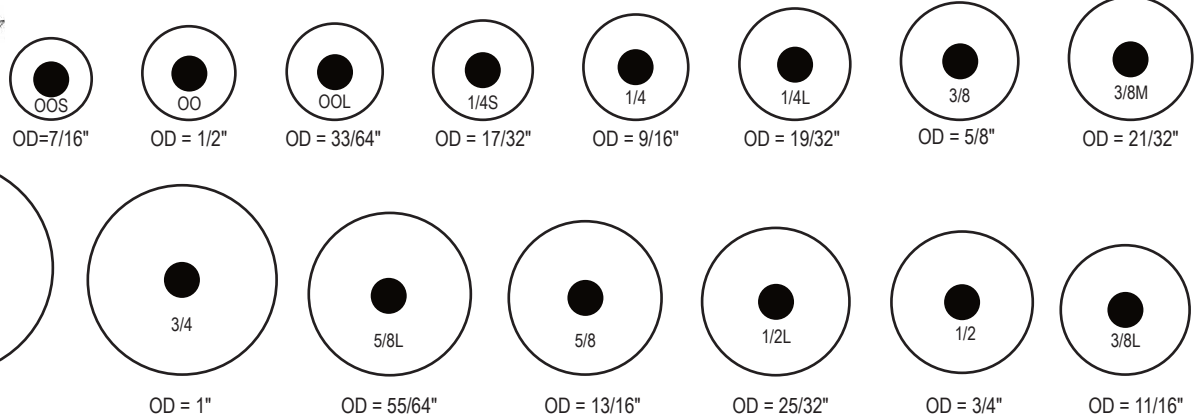

FLAT Washers:

CAT NO.	SIZE:	OD Size:
102 U 001	00S	7/16"
102 U 002	00	1/2"
102 U 003	00L	33/64"
102 U 004	1/4S	17/32"
102 U 005	1/4	9/16"
102 U 006	1/4L	19/32"
102 U 007	3/8	5/8"
102 U 009	3/8M	21/32"
102 U 010	3/8L	11/16"
102 U 011	1/2	3/4"
102 U 012	1/2L	25/32"
102 U 013	5/8	13/16"
102 U 014	5/8L	55/64"
102 U 015	3/4	1"
102 U 016	1	1-1/8"

FULFLO (Beveled) Washers:

CAT NO.	SIZE:	OD Size:
101 U 001	00S	7/16"
101 U 002	00	1/2"
101 U 003	00L	33/64"
101 U 004	1/4S	17/32"
101 U 005	1/4	9/16"
101 U 006	1/4L	19/32"
101 U 007	3/8	5/8"
101 U 009	3/8M	21/32"
101 U 010	3/8L	11/16"
101 U 011	1/2	3/4"
101 U 012	1/2L	25/32"
101 U 013	5/8	13/16"
101 U 014	5/8L	55/64"
101 U 015	3/4	1"
101 U 016	1	1-1/8"

Go ahead...try it!



Take the famous Buna-N Pliers Test -- Crest/Good's Buna-N Heat-Pruf® washer is the only washer that can take the "twist and pull" of two pairs of pliers. Ordinary washers will break under the stress of this test.

Washer Assortment Kits

Mini Assortment of Small Sizes

SIZES INCLUDED:

OO, OOL, 1/4S, 1/4, 1/4L, 3/8

CONTENTS:

100 Buna-N washers in a 6 compartment Crestolac box.
Sorting index included on cover.
Box dim: 4.5" x 3" x 1.5"



CAT NO.	#	Description
101U095	50	Ful-Flo (Beveled) Assortment
102U095	51	Flat Assortment

Small Assortment of Large Sizes

SIZES INCLUDED:

1/2, 1/2L, 5/8, 5/8L, 3/4, 1

CONTENTS:

82 Buna-N washers in a 9 compartment Crestolac box.
Sorting index included on cover.
Box dim: 7" x 3.5" x 1.5"



CAT NO.	#	Description
101U090	5	Ful-Flo (Beveled) Assortment
102U090	6	Flat Assortment



INDIVIDUAL PARTS / FAUCET REPAIRS

CREST/GOOD'S EXCLUSIVE BUNA-N HEAT-PRUF™ FAUCET WASHERS

Washer Assortment Kits (cont.)

Medium Assortment of Small Sizes

SIZES INCLUDED:

OO, OOL, 1/4S, 1/4,
1/4L, 3/8, 3/8M, 3/8L, 1/2

CONTENTS:

285 Buna-N washers in a
12 compartment Crestolac box.
Sorting chart included on cover.
Box dim: 8.25" x 4.5" x 1.5"



CAT NO.

101U091 10 Ful-Flo (Beveled) Assortment
102U091 11 Flat Assortment

Large Assortment of All Sizes

SIZES INCLUDED:

OO, OOL, 1/4S, 1/4, 1/4L,
3/8, 3/8M, 3/8L, 1/2,
1/2L, 5/8, 5/8L, 3/4, 1

CONTENTS:

464 Buna-N washers in a
12 compartment Crestolac box.
Sorting chart included on cover.
Box dim: 10.75" x 6.75" x 1.75"



CAT NO.

101U093 43 Ful-Flo (Beveled) Assortment
102U093 44 Flat Assortment

Large Assortment of Small Sizes (Flat AND Ful-Flo)

SIZES INCLUDED:

OO, OOL, 1/4S, 1/4, 1/4L,
3/8, 3/8M, 3/8L, 1/2,

CONTENTS:

464 Buna-N washers in a
12 compartment Crestolac box.
Sorting chart included on cover.
Box dim: 10.75" x 6.75" x 1.75"



CAT NO.

101U092 42 Flat AND Ful-Flo Assortment

Large Assortment of Small Sizes (Plus Bibb Screws and Tap)

SIZES INCLUDED:

OO, OOL, 1/4S, 1/4, 1/4L, 3/8,
3/8M, 3/8L, 1/2,
plus Bibb Screws & Jiffy Tap

CONTENTS:

403 Buna-N washers in a
12 compartment Crestolac box.
Sorting chart included on cover.
Box dim: 10.75" x 6.75" x 1.75"



CAT NO.

101U094 45 Ful-Flo (Beveled) Assortment
102U094 46 Flat Assortment

GOLD PAK WASHER ASST.

Contains 2 ea of flat washers: OO,
OOL, 1/4S, 1/4, 1/4L, 3/8, 3/8L,
& 2 ea of these bibb screws: 3/8 x
10/24, 3/8 x 8/32, and 1/4 x 8/32.



CAT NO.

CM100 Washer/screw kit

SPECIALTY WASHERS



AM/STD



CHICAGO



CHICAGO



CRANE



DELTA



FISHER



P/P



P/P

CAT NO.

CAT NO.	OD	ID	FOR:
132R001	3/4"	N/A	Am/Std
132R002	3/8"	N/A	Am/Std
942N001	9/16"	1/4"	Chicago
942N002	9/16"	1/4"	Chicago
949F035	9/16"	1/4"	Chicago
211G017	--	--	Chicago
211G018	--	--	Chicago
943R001	3/4"	7/16"	Crane
943R002	3/4"	7/16"	Crane
949C009	3/4"	7/16"	Crane
944R001	7/16"	7/32"	Delta
944T004	7/16"	7/32"	Delta
990L003	7/16"	7/32"	Delta
937F080	9/16"	3/16"	Fisher
937F081	1"	3/16"	Fisher
123R001	5/8"	1/4"	Price Pfister
990R002	5/8"	3/8"	Price Pfister

NOTES:

Tophat style for Aquaseal stems
Small Tophat style for NuSeal (Cadet) Stems
Hard washer for Quatern cartridges
Semi-Hard washer for self closing faucets
Soft washer for Naiad cartridges
2 piece packing for old style Quatern stems
2 piece packing for new style Quatern stems
Semi-Hard washer for Dial-Ese faucets
Hard washer for Hospital faucets
Soft washer for Magic-close faucets
Seat, rubber, for single handle faucets
Seat, silicone, for single handle faucets
Old Style (small) seat for single handle faucets
1/4" concave washer for standard faucets
3/4" concave washer for pot filler faucets
Stem washer for washerless faucet
Stem washer for washerless faucet



INDIVIDUAL PARTS / FAUCET REPAIRS

CREST/GOOD'S EXCLUSIVE TRIPLE LOCK BIBB SCREWS

With the **Triple-Lock Faucet screw and Jiffy Tap System**, you'll never be caught without the right screw for the job, or loaded down with a thousand and one useless screws, either. In competitor's faucet screw assortments, 70% of the screws are wasted, because they are never used. This waste is eliminated with the 10/24 Jiffy Tap System, since all of the screws in the can are 10/24 thread-pitch. Screws are nickel plated brass with a large slot so you can use a full sized screwdriver. The cleats under the head lock the washer to the screw, and the poly plug in the screw shank locks the screw in two spots to the stem.



GOOD

- Nickel plated brass
- Large slotted top

CAT NO.	LGTH:	Thread	#
226 C 007	3/8"	10/24	12P

Standard package = 125 pc.

BETTER

- Nickel plated brass
- Large slotted top
- Washer anchor cleats

CAT NO.	LGTH:	Thread	#
226 C 001	3/8"	6/32	1
226 C 002	3/8"	8/32	4
226 C 003	1/2"	8/32	6

Standard package = 125 pc.

BEST

- Nickel plated brass
- Large slotted top
- Washer anchor cleats
- Dual sided poly plug

CAT NO.	LGTH:	Thread
225 C 001	3/8"	10/24
225 C 002	1/2"	10/24

Standard package = 125 pc.

BIBB SCREW ASSORTMENTS

Assortments include 152 pieces of the 10/24 triple lock screws shown above ("BEST") in a screw top metal can, as well as a 10/24 Jiffy Tap tool.

CAT NO.	Qty of 3/8" screws	Qty of 1/2" screws	Asst #
225C091	134	18	1
225C092	18	134	2
225C093	---	152	3
225C094	152	---	4
225C095	76	76	5

MONEL SCREWS & ASSORTMENTS

Crest/Good specialty Monel screws are made of a corrosion proof alloy, and simply will not rust. The nylon plug imbedded in the thread area locks the screws to the stem, and the cleats under the head assure the washer is anchored in place.

CAT NO.	LGTH:	Thread
221 M 005	3/8"	8/32
221 M 006	3/8"	10/32

ASSORTMENT:
221 M 093 100pc: 8/32 plus 30pc: 10/32

JIFFY TAP TOOL

Crest/Good hardened steel tap enlarges threads to 10/24, and cleans out damaged threads.

CAT NO.	Description:
561I001	Jiffy Tap Tool complete
561I002	Tap only (less handle)
561I003	Handle only (less tap)
226C006	Lock screw only

FAUCET SCREW DRILL
"The only drill that really works..."

- Drills out corroded faucet screws quickly.
- Automatically centers both long & short faucet stems with one single motion.
- Dual purpose handle has 10/24 Jiffy Tap for rethreading the stem.
- Small enough to carry in your tool box.
- Eliminates the need of running around to find a replacement stem, or the need of using an electric drill and vice to drill out broken screws.

CAT NO.	DESCRIPTION
591 I 062	Faucet Screw Drill

ECONOMY (PLAIN BRASS) SCREW ASSORTMENT

200 Plain brass screws in 8 different sizes. Packaged in an 8 compartment plastic box. This is the perfect kit for the economy minded plumber.

Sizes include:
6/32 thread x 3/8";
8/32 thread x 1/4", 3/8", & 1/2";
10/24 thread x 3/8" & 1/2";
and
10/28 thread x 3/8" & 1/2".

ASSORTMENT:
225C096 200pc bibb screw assortment

HANDLE SCREWS ARE FOUND ON PAGE 1-5



INDIVIDUAL PARTS / FAUCET REPAIRS

CREST/GOOD'S STAINLESS STEEL WASHER RETAINERS

Use these retainer cups to rebuild stems like new -- just file off the retainer wall and install the new washer retainer cup. Made of triple nickel plated brass to ensure a corrosion free life.

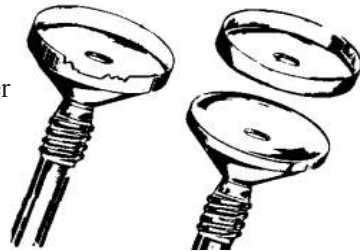

CAT NO.	#	OD:	Fits Washer Sizes
146 C 001	00	35/64"	00S & 00
146 C 002	0	19/32"	00L & 1/4S
146 C 003	1/4	39/64"	1/4
146 C 004	1/4L	5/8"	1/4L
146 C 005	3/8	21/32"	3/8
146 C 006	3/8M	11/16"	3/8M
146 C 007	3/8L	47/64"	3/8L
146 C 008	1/2	25/32"	1/2

WASHER RETAINER ASSORTMENT

136 piece retainer assortment. (Includes all sizes listed above.)



CAT NO.	#
146 C 090	27

6-IN-1 & 5-IN-1 SCREWDRIVERS

The shank of the six-in-one acts as a 1/4" hex nut driver on one end, and a 5/16" hex nut driver on the other. Includes large and small philips and slotted bits. The five-in-one has a shank that is 5/16 on both ends.

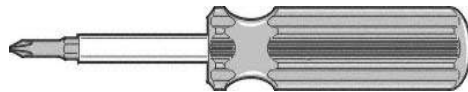

CAT NO.	DESCRIPTION
591 I 206	6-in-1 Screwdriver
591 I 205	5-in-1 Screwdriver

-replacement bits found on page 6-10

MORE SCREWDRIVERS SHOWN ON PAGE 6-12.

CREST/GOOD KEY GREASE

White, odorless, tasteless, non-rancid formula. Won't wash off at high temperatures. Heatproof to 325°. Attached lid can't get lost.



CAT NO.	DESCRIPTION:
843-004	1/2 oz. plastic container
843-005	2 oz. plastic container
843-501	MSDS Sheet for Key Grease

HEX KEY WRENCH SET

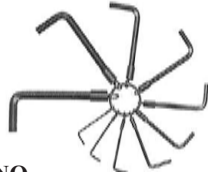

CAT NO.	DESCRIPTION:
591 I 171	10 pc SAE set
591 I 191	10 pc Metric set

THREAD CHECKER TOOL



CAT NO.	DESCRIPTION:
591 I 633	13 Leaf thread checker

HANDLE SCREWS

Save money with our exclusive 10/24 threaded handle screws and Jiffy Tap tool...One thread size to fit all faucet handles. Our handle screw assortment (see page 1-37) includes tap tool plus screw chart and manufacturers' listing of charts.



ROUND HEAD



TRUSS HEAD



OVAL HEAD



FILLISTER HEAD

CAT NO.	#	HEAD:	SIZE:
226 C 002	107	Round	8-32 x 1/2"
947 B 300		Round	8-32 x 3/4"
227 C 067		Round	8-32 x 1"
227 C 001*	110	Round	10-24 x 3/8"
227 C 002*	111	Round	10-24 x 1/2"
227 C 066		Round	10-24 x 1"
861 A 010		Round	10-32 x 3/4" (plain brass)
227 C 068		Round	10-32 x 1"
947 S 021		Truss	4-40 x 1/2"
227 C 003	112	Truss	10-24 x 3/8"
227 C 016		Truss	10-24 x 1/2"
227 C 006*	115	Lg. Oval	10-24 x 3/8"
227 C 007*	116	Lg. Oval	10-24 x 1/2"
227 C 008	120	Lg. Oval	10-32 x 1/2"
227 C 017*	1970	Lg. Oval	10-24 x 3/4"
947 S 687		Oval	6-32 x 3/8"
227 C 015		Oval	8-32 x 1/2"
227 C 028		Oval	8-32 x 3/4"
227 C 030		Oval	8-32 x 1-3/4"
227 C 024*	117	Oval	10-24 x 5/8"
227 C 026*	119	Oval	10-24 x 1-1/2"
227 C 029		Oval	10-24 x 2-1/2" (PAIR)
960 A 310		Oval	10-28 x 1/2"
227 C 027	122	Oval	10-32 x 3/4"
227 C 009	103	Fillister	8-32 x 5/16" (plain brass)

*(included in our Handle Screw Assortment Kit shown on page 1-37)

SET SCREWS

Stainless steel set screws for a variety of uses. Hex head unless noted. Screws marked with * included in kit 223C090

CAT NO.	Thread:	Length:
223C001	4-40	x 1/8
223C002	4-40	x 3/16
223C003	4-40	x 1/4
223C004	4-40	x 5/16
223C005	4-40	x 3/8
223C006	4-40	x 1/2
947S021	6-32	x 1/8 (SLOTTED)
223C011*	6-32	x 1/8 (Logan)
223C012	6-32	x 3/16 (Logan)
223C013*	6-32	x 1/4
223C014	6-32	x 5/16
223C015*	6-32	x 3/8
223C016	6-32	x 1/2
223C021	8-32	x 1/8
223C022	8-32	x 3/16
223C023*	8-32	x 1/4
223C024	8-32	x 5/16
223C025*	8-32	x 3/8
223C026	8-32	x 1/2
223C027	8-32	x 3/4 (Kohler)
223C031	10-24	x 1/8
223C032	10-24	x 3/16 (Speakman)
223C033*	10-24	x 1/4 (Tap tool)
223C034	10-24	x 5/16
223C035	10-24	x 3/8
223C036*	10-24	x 1/2
223C037*	10-24	x 3/4 (Price Pfister)



CAT NO.	Thread:	Length:
223C041	10-32	x 3/16
223C042*	10-32	x 1/4 (Logan)
223C043	10-32	x 5/16
223C044*	10-32	x 3/8 (Acorn)
223C045*	10-32	x 1/2
223C051	1/4-20	x 3/16 (Speakman)
223C052*	1/4-20	x 1/4
223C053	1/4-20	x 5/16
223C054*	1/4-20	x 3/8 (Kohler)
947A011	1/4-20	x 1/2 (SLOTTED)
223C055*	1/4-20	x 1/2 (Symmons)
223C061	1/4-28	x 3/16 (Am.Std)
223C062	1/4-28	x 1/4
223C063*	1/4-28	x 5/16 (Delta)
223C064	1/4-28	x 3/8 (Symmons)
223C071	5/16-18	x 1/4
223C072	5/16-18	x 5/16
223C073*	5/16-18	x 3/8
223C074*	5/16-18	x 1/2

SET SCREW ASSORTMENT

250 piece cup point stainless set screw assortment. (Includes starred sizes listed above.)

CAT NO.	DESCRIPTION:
223 C 090	



INDIVIDUAL PARTS / FAUCET REPAIRS

CREST/GOOD SOLID BRASS FRICTION RINGS (shown actual size)

1
2
3
4
5
6
7
8
9

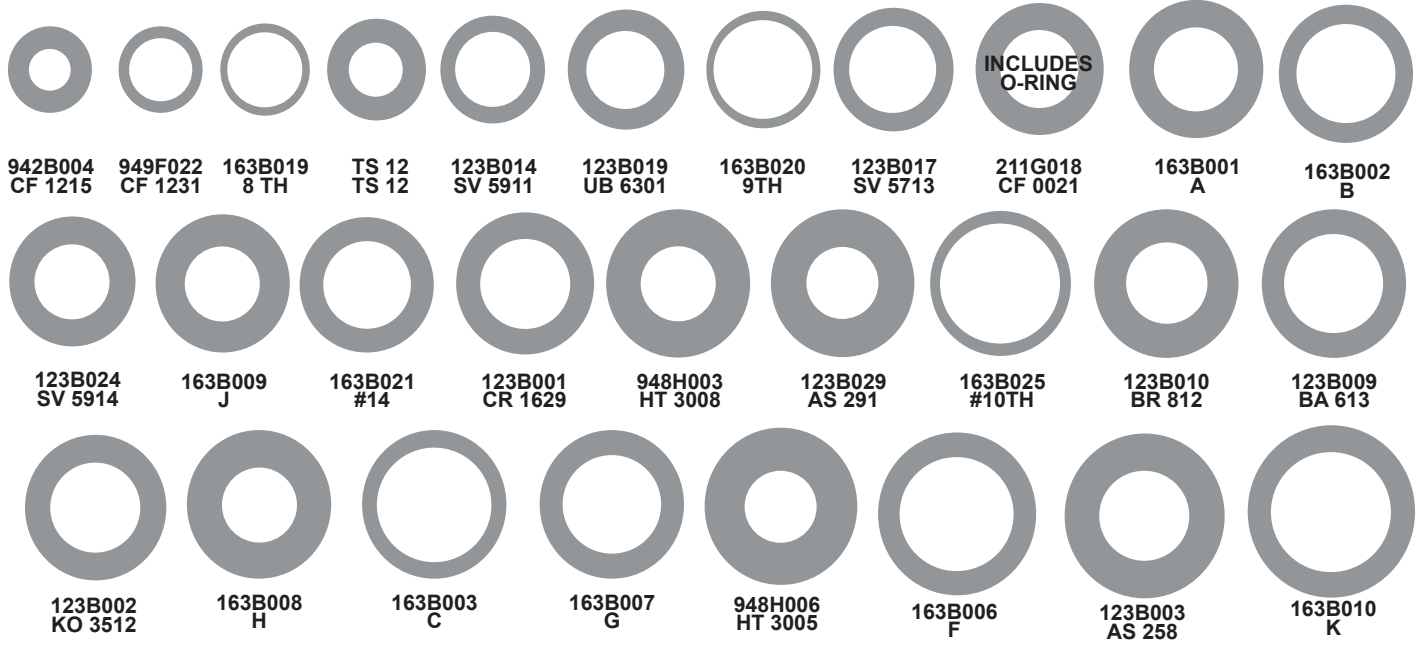

SOLID BRASS FRICTION RINGS:

CAT NO.	NO:	O.D.	I.D.	Thick:
123 B 001	CR 1629	23/32"	15/32"	3/64"
123 B 002	KO 3512	25/32"	15/32"	3/64"
123 B 003	AS 258	27/32"	15/32"	3/64"
123 B 004	CB 1106	29/32"	15/32"	3/64"
123 B 005	CB 1105	1"	15/32"	3/64"
123 B 008	KO 3521	7/8"	7/16"	3/64"
123 B 009	BA 613	3/4"	33/64"	1/16"
123 B 010	BR 812	3/4"	27/64"	3/32"
123 B 014	SV 5911	35/64"	25/64"	1/32"
123 B 017	SP 5713	5/8"	29/64"	3/64"
123 B 019	UB 6301	39/64"	13/32"	1/32"
123 B 021	SY 6011	7/8"	13/32"	3/64"
123 B 029	AS 291	3/4"	3/8"	3/64"
211 G 018	CF 0021	43/64"	13/32"	1/16"
942 B 004	CF 1215	7/16"	7/32"	1/32"
948 H 006	HT 3005	53/64"	3/8"	3/32"
948 H 003	HT 3008	3/4"	25/64"	3/64"
949 F 022	CF 1231	7/16"	21/64"	1/32"
163 B 001	A	45/64"	7/16"	3/64"
163 B 002	B	45/64"	33/64"	1/32"
163 B 003	C	13/16"	11/16"	3/64"
163 B 006	F	53/64"	19/32"	3/64"
163 B 007	G	13/16"	33/64"	1/32"
163 B 008	H	13/16"	25/64"	1/32"
163 B 009	J	45/64"	25/64"	1/32"
163 B 010	K	7/8"	5/8"	1/32"
163 B 012	1-1/4" S.J.	1-31/64"	1-17/64"	1/32"
163 B 013	#3	1-23/32"	1-17/64"	1/32"
163 B 015	1-1/2" S.J.	1-23/32"	1-33/64"	1/32"
163 B 017	2" S.J.	2-3/16"	2-1/64"	1/32"
163 B 019	#8TH	15/32"	25/64"	1/32"
163 B 020	#9TH	19/32"	33/64"	1/32"
163 B 021	14	45/64"	29/64"	1/32"
163 B 025	10TH	47/64"	5/8"	3/64"
TS 12	TS 12	33/64"	9/32"	1/32"

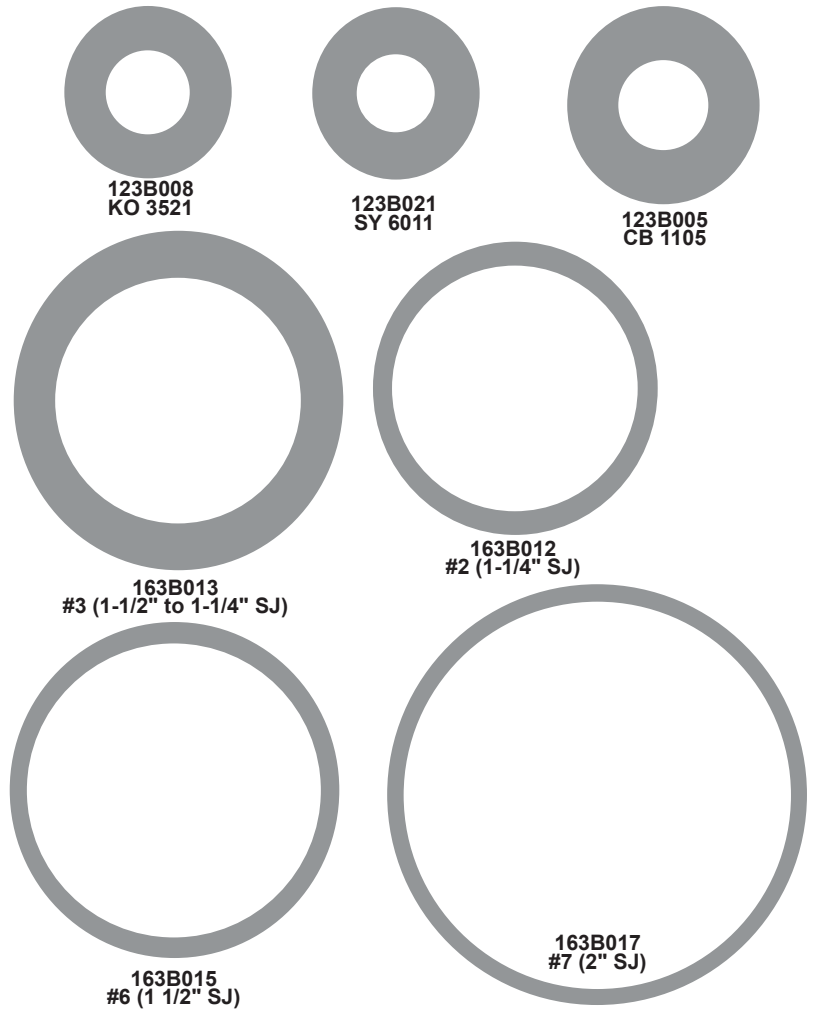

INDIVIDUAL PARTS / FAUCET REPAIRS

CREST/GOOD SOLID BRASS SPOUT WASHERS (shown actual size)

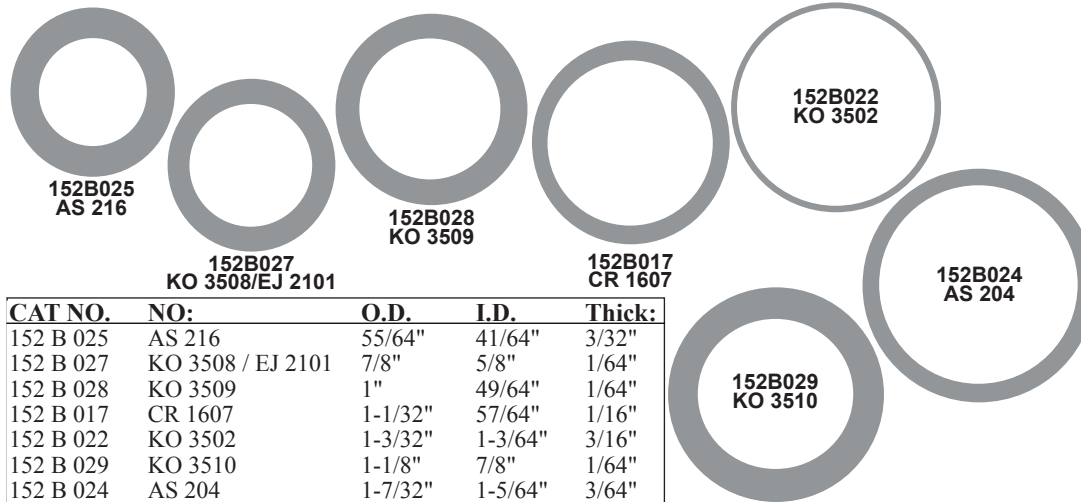

CAT NO.	NO:	O.D.	I.D.	Thick:
152 B 025	AS 216	55/64"	41/64"	3/32"
152 B 027	KO 3508 / EJ 2101	7/8"	5/8"	1/64"
152 B 028	KO 3509	1"	49/64"	1/64"
152 B 017	CR 1607	1-1/32"	57/64"	1/16"
152 B 022	KO 3502	1-3/32"	1-3/64"	3/16"
152 B 029	KO 3510	1-1/8"	7/8"	1/64"
152 B 024	AS 204	1-7/32"	1-5/64"	3/64"

CREST/GOOD DIVERTER WASHERS (shown actual size)

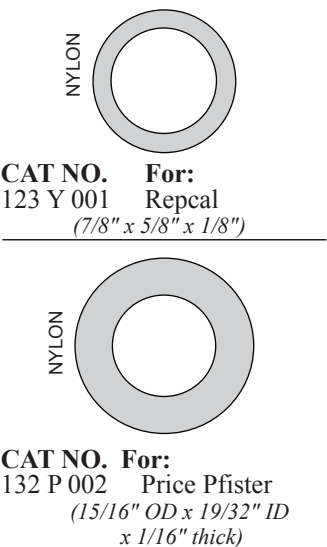

CAT NO. For:
123 Y 001 Repeal
(7/8" x 5/8" x 1/8")

CAT NO. For:
132 P 002 Price Pfister
(15/16" OD x 19/32" ID x 1/16" thick)

CAT NO. For:
132 P 003 Eljer
(11/16" x 17/32" x 3/32")

CAT NO. For:
132 R 004 Sterling
(15/16" OD x 9/16" ID x 3/16")

CREST/GOOD SOLID BRASS SPOUT SNAP RINGS (shown actual size)

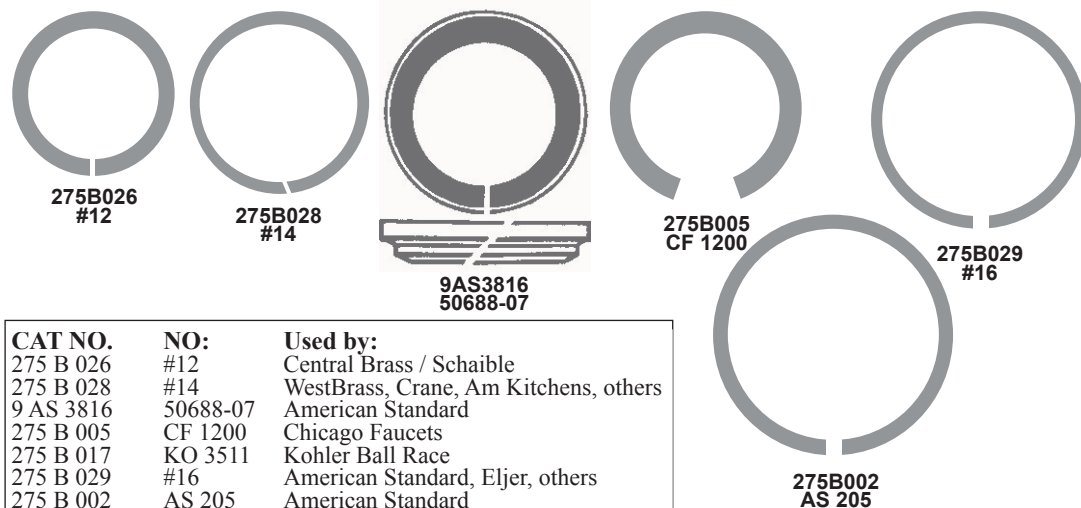

CAT NO.	NO:	Used by:
275 B 026	#12	Central Brass / Schaible
275 B 028	#14	WestBrass, Crane, Am Kitchens, others
9 AS 3816	50688-07	American Standard
275 B 005	CF 1200	Chicago Faucets
275 B 017	KO 3511	Kohler Ball Race
275 B 029	#16	American Standard, Eljer, others
275 B 002	AS 205	American Standard

TEFLON DISCS (for extremely hot water)

TEFLON VALVE DISCS

For Jenkins, Luckenheimer, Crane, Walworth, Kennedy and Other Valves. The finest valve discs for long-lasting and trouble-free service on hot water, steam, caustic and acid lines. Chemically inert; they will stand temperatures from minus 300°f to 500°f and withstand pressures up to several thousand pounds; and won't react with acids. Other sizes available by special order.

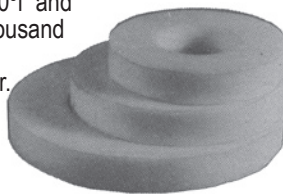

CAT NO.	SIZE	O.D.	I.D.	THK.
863 T 002	3/8"	25/32"	1/4"	7/32"
863 T 003	1/2"	13/16"	1/4"	1/4"

BALL RACES (for self closing fountains)

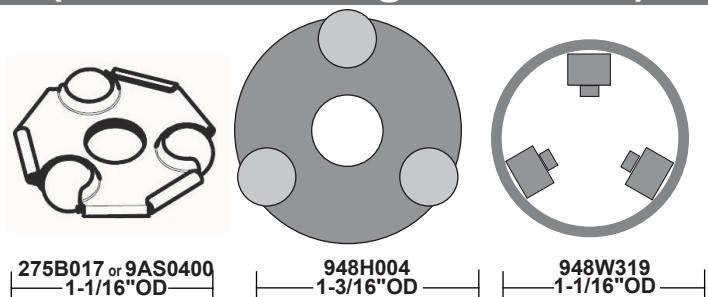

CAT NO.	NO:	Used by:
275 B 017	31537	Kohler, others (ID: 3/8")
9AS0400	527-1700	American Standard, others (ID: 5/16")
948H004	HT 3009	Central Brass, Halsey Taylor, others
948W319	5800VRKR	Haws (included in a kit that contains other parts)



INDIVIDUAL PARTS / FAUCET REPAIRS

CREST/GOOD CUT STEM PACKINGS (shown actual size)

STEM PACKING

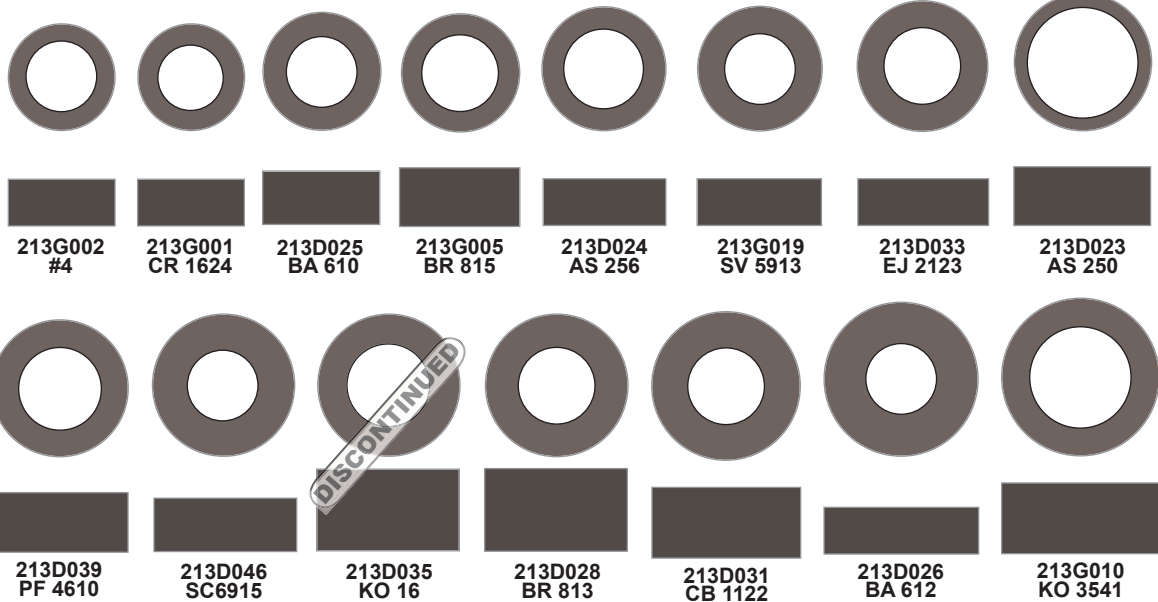
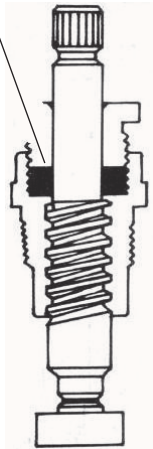

213G002 #4 213G001 CR 1624 213D025 BA 610 213G005 BR 815 213D024 AS 256 213G019 SV 5913 213D033 EJ 2123 213D023 AS 250

213D039 PF 4610 213D046 SC6915 213D035 KO 16 213D028 BR 813 213D031 CB 1122 213D026 BA 612 213G010 KO 3541

SQUARE CUT STEM PACKINGS:

CAT NO.	NO:	Type:	O.D.	I.D.	Thick:
213 D 023	AS 250	C/1	3/4"	37/64"	5/16"
213 D 024	AS 256	C/1	21/32"	27/64"	1/4"
213 D 025	BA 610	C/1	5/8"	3/8"	9/32"
213 D 026	BA 612	C/1	13/16"	3/8"	1/4"
213 D 028	BR 813	C/1	3/4"	13/32"	7/16"
213 D 031	CB 1122	C/1	25/32"	13/32"	3/8"
213 D 033	EJ 2123	C/1	11/16"	13/32"	1/4"
213 D 035	KO 16	C/1	3/4"	7/16"	3/32"
213 D 036	KO 3520	C/1	7/8"	7/16"	3/8"
213 D 039	PF 4610	C/1	23/32"	7/16"	1/32"
213 D 041	RC 4805	G	7/8"	3/8"	3/32"
213 D 046	SC-6915	C/1	3/4"	3/8"	9/32"
213 G 001	CR 1624	G	9/16"	11/32"	1/4"
213 G 002	#4	G	9/16"	3/8"	1/4"
213 G 003	AS 284	G	29/32"	9/16"	5/32"
213 G 005	BR 815	G	5/8"	13/32"	5/16"
213 G 008	GB 2514	G	7/8"	3/8"	3/8"
213 G 010	KO 3541	G	53/64"	17/32"	3/8"
213 G 019	SV 5913	G	21/32"	3/8"	1/4"

Key: C/1 = Grade 1 reinforced cut rubber
G = Graphite



213G008 GB 2514 213D036 KO 3520 213D041 RC 4805 213G003 AS 284

STEM & BONNET PACKING ASSORTMENT

Our #4 Stem & Bonnet Packing Assortment contains 108 different packings in 25 clear plastic boxes, all packed into a metal carrying case, and featuring a full-size sizing chart inside the lid. Simply match up desired packing on chart, and select replacement.



CAT NO. # Description
213 G 090 4 108 piece Stem & Bonnet Assortment

CREST/GOOD MIXING YOKE GASKETS (shown actual size)

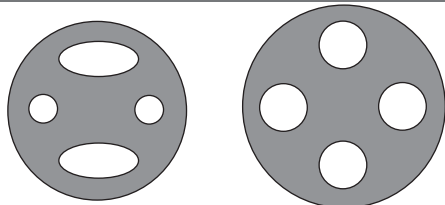

9CF0093

TS13F

CAT NO.	Brand:	OEM:	O.D.
9CF0093	Chicago, Briggs, Eljer	50-8	15/16"
TS13F	T&S Brass	1041-45	1-1/16"

FLOW CONTROL RESTRICTORS

For Acorn, Elkay, Oasis, and other valves.
Bag of 10.

CAT NO.	GPM
9AN0304	0.4
9AN0305	0.5
9AN0307	0.7
9AN0310	1.0
9AN0314	1.4
9AN0322	2.2
9AN0325	2.5

MORE INFO SHOWN ON PAGE 2-4.



INDIVIDUAL PARTS / FAUCET REPAIRS

CREST/GOOD BONNET PACKINGS (shown actual size)

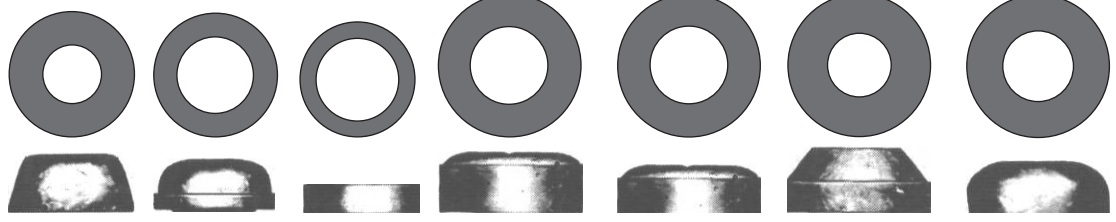
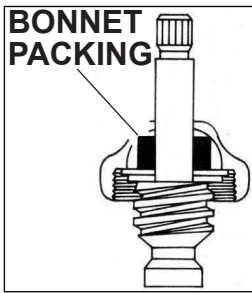

211G003
AS 270

211T006*
CF 1217

□□□□□□
□□□□□□

□□□□ □□
□□□□ □□

212G006
KO 3526

212G010
SF 5311
211T016
UR 6410T

211T007
SC 6901T
165R004
(for angle stops)

BONNET NUT PACKINGS:

CAT NO.	NO:	Type:	O.D.	I.D.	Thick:
211 G 003	AS 270	D/G	21/32"	5/16"	9/32"
211 T 001	SP 57008T	T	5/8"	7/16"	3/16"
211 T 006*	CF 1217T	T	21/32"	13/32"	1/4"
211 T 007	SC 6901T	T	3/4"	3/8"	9/32"
211 T 012	AK 201T	T	7/8"	3/8"	7/16"
211 T 013	KO 3528T	T	15/16"	7/16"	1/4"
211 T 014	AS 219T	T	1"	7/16"	5/16"
211 T 016	UR 6410T	T	3/4"	13/32"	19/64"
212 G 005	KO 3524	F/G	3/4"	13/32"	5/16"
212 G 006	KO 3526	F/G	3/4"	13/32"	1/4"
212 G 007	KO 3528	F/G	29/32"	3/8"	9/32"
212 G 008	SC 6910	F/G	25/32"	13/32"	5/16"
212 G 009	SF 5310	F/G	31/32"	7/16"	1/2"
212 G 010	SF 5311	F/G	3/4"	11/32"	5/16"
212 G 013	AK 201	F/G	7/8"	3/8"	7/16"
212 G 014	SY 6012	F/G	1"	7/16"	5/16"
212 G 022	SY 6016	F/G	7/8"	7/16"	3/8"

Key: F/G = Flanged Graphite
D/G = Domed Graphite
T = Teflon

SPECIAL WASHER FOR ANGLE STOP VALVES

3/4" OD x 3/8" ID x 1/8" thick
CAT NO: 164 R 005

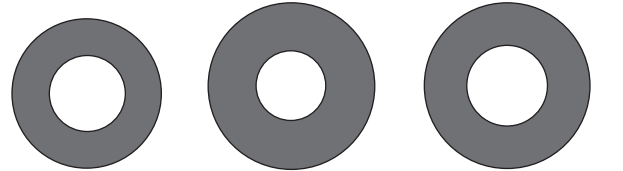

212G008
SC 6910



212G013
AK 201
211T012
AK 201T

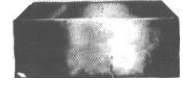

212G022
SY 6016

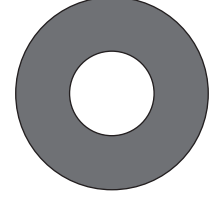
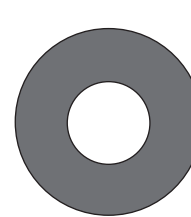
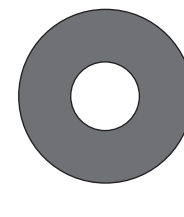

212G007
KO 3528
211T013
KO 3528T



212G009
SF 5310



212G014
SY 6012
211T014
AS 219T

*Special note for Chicago Faucets:

Quatern stems *originally* used a teflon packing, (our 211T006, shown above). In later years, a three piece assembly was used, consisting of an O-ring, a "duck" washer, and a brass friction ring. 1997, Chicago Faucets converted to a 2 piece bonnet packing set, (our 211G018,) consisting only of a larger O-ring and friction ring.

Order # 211G018 (Naiad New style 2 pc bonnet packing kit)

TEFLON AND GRAPHITE PACKING STRING

TEFLON STRING

"ZIP JOINT" is the fastest way to make a gasket or pack a valve. Seals practically everything, will form to any size or shape to make a positive seal on faucet stems, pump shafts, flanged pipe joints. Can be used in place of sheet packing on boiler inspection plates. Has almost no liquid or gas service limitations. Temperature Range: 40° to 500° F. Pressures up to 1500 PSI under proper applications.



CAT NO. 919 T 007
SIZE: 3/32" x 50' Length

GRAPHITE DACRON STRING FOR STEM PACKING

Used on water, steam, air or oil Valves. Contains no asbestos.



CAT NO. 918 G 050 1/8" 12 Ft.
918 G 051 1/4" 8 Ft.

GRAPHITE STRING

For those customers who don't want to buy 12 feet of graphite string, we now sell 12" lengths.

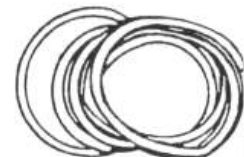

CAT NO: 918G112
SIZE: 1/8" x 12"



INDIVIDUAL PARTS / FAUCET REPAIRS

CREST/GOOD CAP THREAD GASKETS (shown actual size)

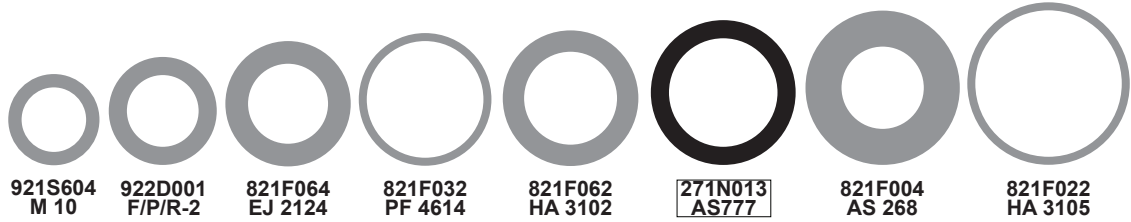
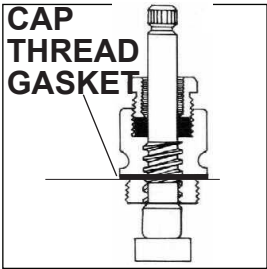

CAP THREAD GASKETS:

CAT NO.	NO:	Type:	O.D.	I.D.	Thick:
271 N 013*	AS777	R	3/4"	9/16"	3/32"
271 N 024*	KO6558	R	7/8"	3/4"	1/16"
271 N 025*	KO6559	R	1-1/16"	15/16"	1/16"
821 A 003*	AS 272	F	1-1/4"	1-1/16"	1/16"
821 A 004*	AS 289	F	27/32"	7/16"	1/16"
821 A 005*	CF 1210	F	1-1/32"	13/16"	1/16"
821 A 006*	CR 1621	F	1-3/32"	13/16"	1/8"
821 A 009*	GB 2519	F	1-1/4"	1"	1/16"
821 A 010	EJ 2112	F	7/8"	23/32"	1/16"
821 D 001*	AS 260	R	1"	7/8"	9/64"
821 D 002*	AS 278	R	1-1/4"	1"	1/8"
821 F 004*	AS 268	F	53/64"	7/16"	1/16"
821 F 005*	AS 290	F	1-1/8"	29/32"	3/32"
821 F 007	BR 817	F	1-1/8"	61/64"	3/32"
821 F 010*	CR 1655	F	1-7/32"	1-5/32"	1/32"
821 F 011*	CR 1656	F	1-11/32"	1-5/32"	1/32"
821 F 013*	CR 1659	F	1-3/8"	1-5/32"	1/16"
821 F 016*	EJ 2126	F	1-1/64"	7/8"	3/32"
821 F 019*	GB 2502	F	1-1/32"	7/8"	1/16"
821 F 022*	HA 3105	F	27/32"	3/4"	1/16"
821 F 026*	KO 3500	F	1-1/16"	3/4"	1/32"
821 F 027	KO 3501	F	1-3/64"	15/16"	1/64"
821 F 028*	KO 3525	F	63/64"	7/8"	3/64"
821 F 029*	MC 3900	F	1-1/16"	7/8"	1/16"
821 F 030*	MC 3924	F	1-1/8"	7/8"	3/32"
821 F 032*	PF 4614	F	47/64"	11/16"	1/32"
821 F 033*	PI 6608	F	1-1/8"	7/8"	1/32"
821 F 034	PI6614	F	1-1/32"	3/4"	1/32"
821 F 036*	RC4812	F	1-9/32"	1"	1/16"
821 F 037*	RC4816	F	15/16"	13/16"	1/16"
821 F 044*	SP5710	F	1-1/16"	7/8"	1/32"
821 F 045*	SP5714	F	1-1/8"	57/64"	1/16"
821 F 046*	SP5717	F	1"	13/16"	1/16"
821 F 048*	SV5912	F	7/8"	3/4"	1/16"
821 F 050*	UB6302	F	31/32"	13/16"	1/16"
821 F 051*	UB6313	F	15/16"	11/16"	1/32"
821 F 054*	WB6715	F	29/32"	23/32"	1/32"
821 F 055*	WB6718	F	1-5/32"	1-1/64"	1/64"
821 F 062	HA 3102	F	3/4"	1/2"	1/64"
821 F 063*	PF 4618	F	1-3/16"	7/8"	1/16"
821 F 064*	EJ 2124	F	21/32"	27/64"	1/16"
821 F 066	BR 819	F	1-29/32"	1-11/16"	3/64"
821 K 001*	KO 3507	F	1-1/8"	15/16"	1/16"
821 R 002*	AS 254	R	1-3/32"	31/32"	3/32"
921 S 202*	RC4905	F	1-7/16"	1-1/16"	1/32"
921 S 604	CN30	F	1/2"	3/8"	1/8"
922 D 001	F/P/R-2	F	9/16"	3/8"	1/16"
924 P 011*	S 11	F	15/16"	3/4"	1/16"

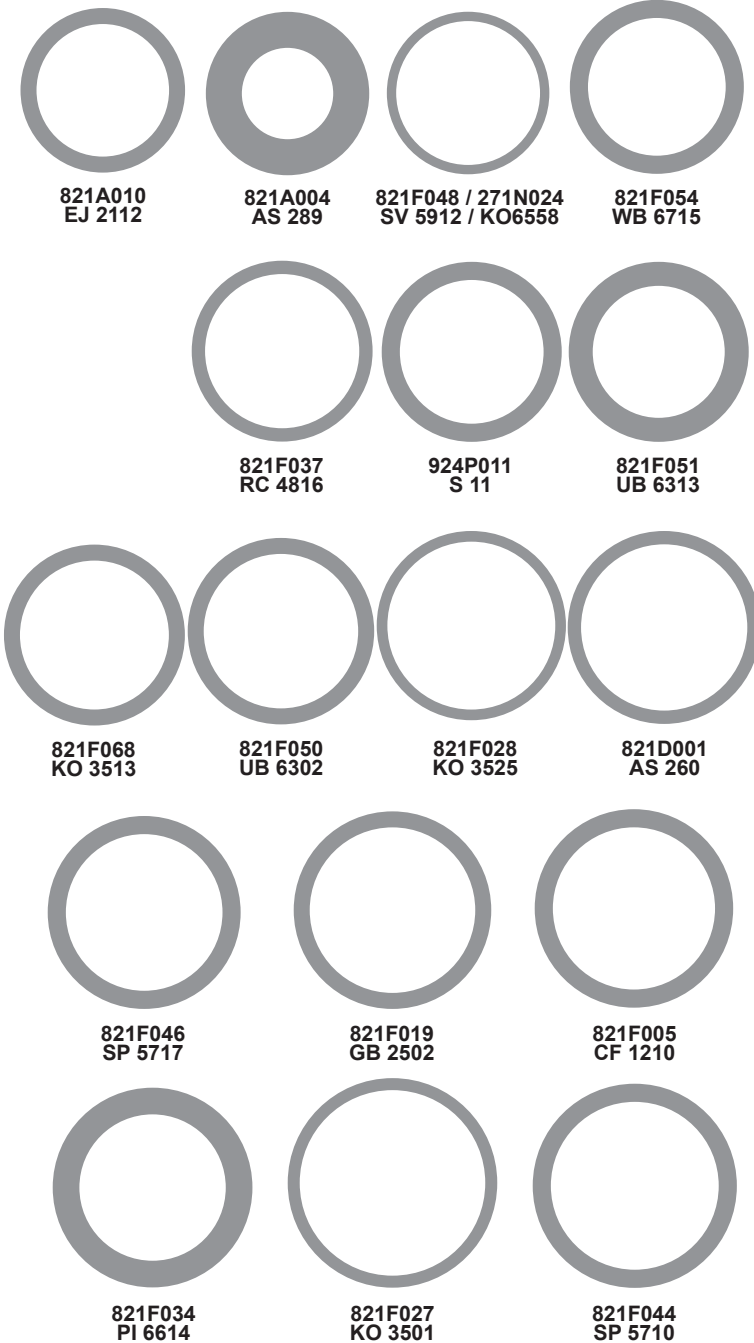

Key: F = Fiber; R = Rubber
* starred items are included in 821F090 kit (shown on page 1-11)

CONTINUED ON NEXT PAGE



INDIVIDUAL PARTS / FAUCET REPAIRS

CREST/GOOD CAP THREAD GASKETS (shown actual size)

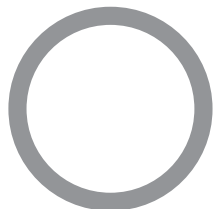

821F029
MC 3900

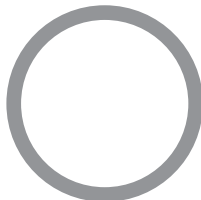

821F016
EJ 2126

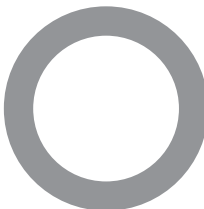

821F026
KO 3500

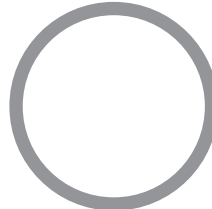

821R002
AS254

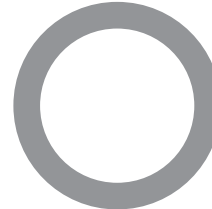

821A006
CR 1621

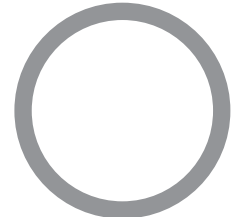

821F007
BR 817



821F005
AS 290



821F045
SP 5714 / WB 6711



821F033 / 821F030
PI 6608 / MC 3924

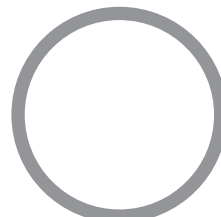

821K001
KO 3507

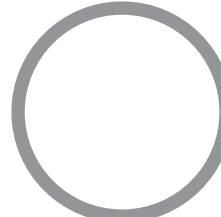

821F055
WB6718



821F063
PF 4618

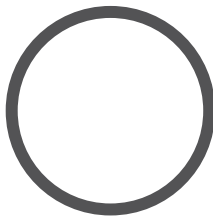

271N025
KO 6559

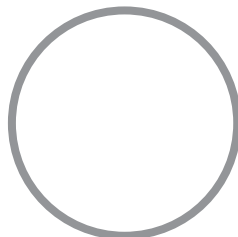

821F010
CR 1655

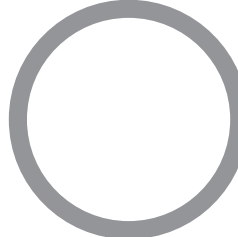

821A003
HT 3001/ AS272

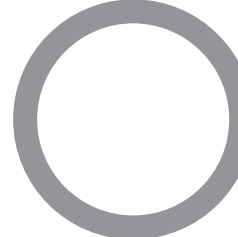

821D002
AS 278

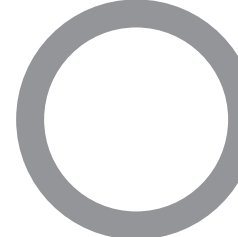

821F011
GB 2519

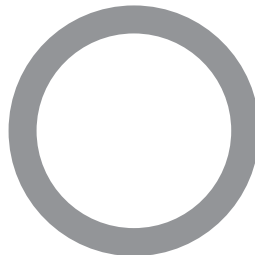

821F036
RC 4812

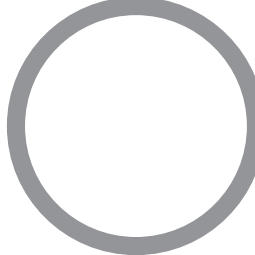

821F011
CR 1656

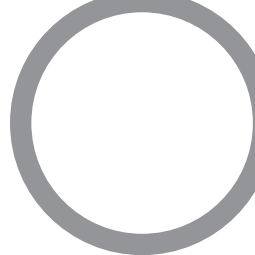

821F013
CR 1659



SLOAN
HANDLE
GASKET

921S202
RS 4905

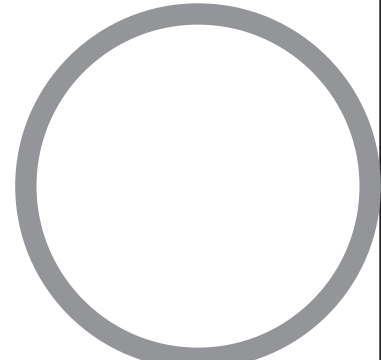

821F036
RC 4812

CAP THREAD ASSORTMENT KIT

For modern faucet stems and flush valves. Contains 335 gaskets in 25 plastic boxes, (over 40 different sizes,) all packed into a sturdy metal carrying case. Includes full sized sizing chart on the inside of the cover. (Included sizes are shown on chart on page 1-10.)



CAT NO.
821F090

Description:
#25 Cap Thread Assortment kit



INDIVIDUAL PARTS / FAUCET REPAIRS

CREST/GOOD SWING SPOUT GASKETS (shown actual size)

1
2
3
4
5
6
7
8
9

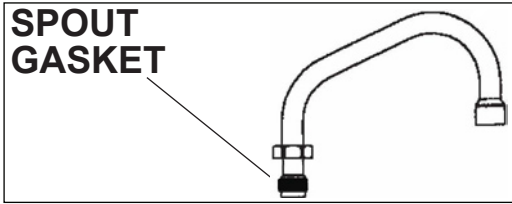
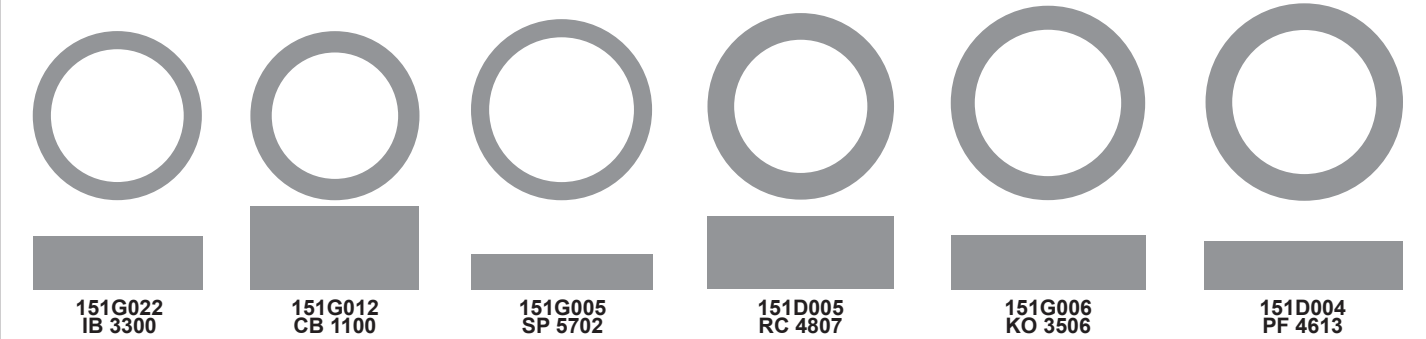
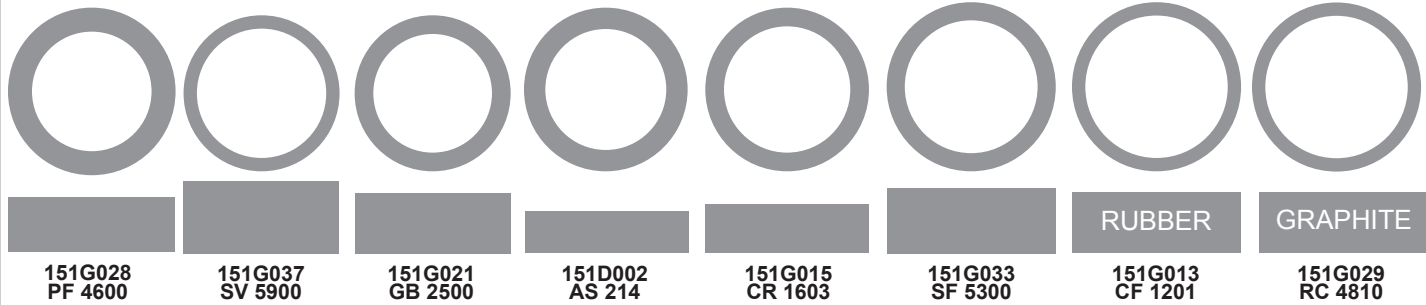

CHICAGO FAUCET SPOUT REPAIR KITS

CAT NO:	DESCRIPTION:
CF51	Swing to rigid conversion kit
CF52	Leaky spout repair kit

SWING SPOUT GASKETS:

CAT NO.	NO:	Type:	O.D.	I.D.	Height:
151 G 028	PF 4600	G	7/8"	9/16"	9/32"
151 G 037	SV 5900	G	13/16"	21/32"	3/8"
151 G 021	GB 2500	G	13/16"	5/8"	5/16"
151 D 002	AS 214	C/1	55/64"	5/8"	7/32"
151 G 015	CR 1603	G	1"	21/32"	1/4"
151 G 033	SF 5300	G	7/8"	11/16"	11/32"
151 G 013	CF 1201	G	7/8"	3/4"	5/16"
151 G 022	IB 3300	G	7/8"	11/16"	9/32"
151 G 029	RC 4810	G	7/8"	3/4"	5/16"
151 G 012	CB 1100	G	7/8"	21/32"	7/16"
151 G 005	SP 5702	G	15/16"	3/4"	3/16"
151 D 005	RC 4807	C/1	31/32"	11/16"	3/8"
151 G 006	KO 3506	G	1"	3/4"	9/64"
151 D 004	PF 4613	C/1	1-1/32"	3/4"	1/4"
151 G 034	SP 5700	G	1-1/16"	3/4"	1/4"
151 G 023	IB 3301	G	1-1/16"	3/4"	3/32"
151 G 025	KO 3505	G	1-1/8"	7/8"	3/16"
151 G 040	UR 6400	G	1-1/8"	57/64"	5/16"
151 G 019	EJ 2105	G	1-5/16"	1-1/16"	9/32"
151 G 008	AS 210	G	1-5/16"	7/8"	1/16"

Key: C/1 = Grade 1 reinforced cut rubber
G = Graphite

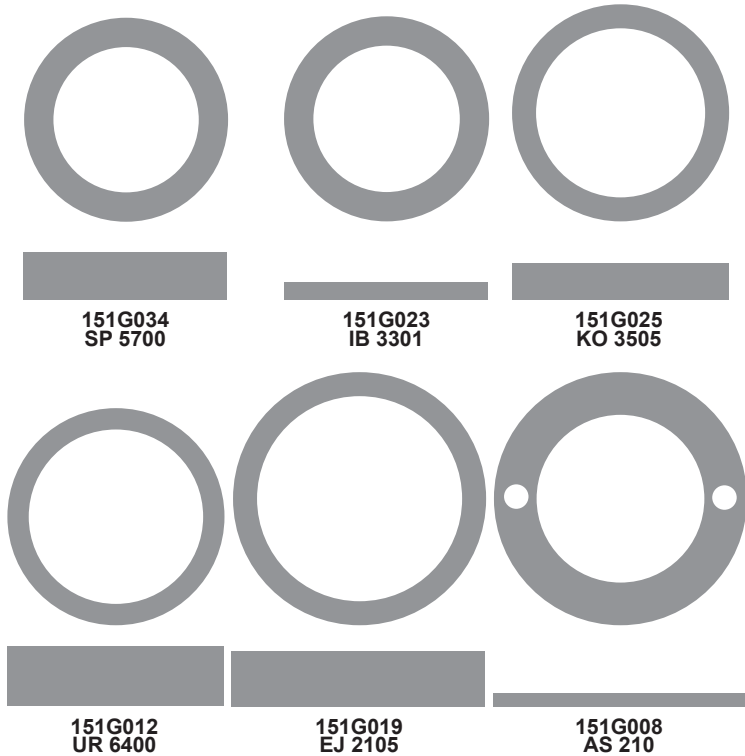

INDIVIDUAL PARTS / FAUCET REPAIRS

CREST/GOOD BUNA-N O-RINGS (shown actual size)

- Tough-made of our famous Buna-N rubber compound, the same compound that is used in airplane tires.
- Heat Proof - Crest/Good O-Rings can withstand temperatures up to 180° -- will NOT distort or crack.
- No Callbacks - Proven callback proof by thousands of plumbers & contractors for decades.



CAT NO.	NO:	O.D.	I.D.	Thick:	Fits (partial listing only):
271 N 001	1	5/8"	1/2"	1/16"	Am/Std, Kohler, Speakman
271 N 002	2	5/16"	3/16"	1/16"	Am/Std, Kohler, Speakman
271 N 003	3	11/32"	7/32"	1/16"	Kohler flushometer
271 N 004	4	1/2"	3/8"	1/16"	Am/Std, Powers, U/R, Sayco
271 N 005	5	3/8"	1/4"	1/16"	Acme, Crane, Kohler
271 N 006	6	7/16"	5/16"	1/16"	Central, Chicago, Kohler, Watts
271 N 007	7	USE 271N009			
271 N 008	8	9/16"	3/8"	3/32"	Gerber, Harcraft Kohler, Pr/Pf
271 N 009	9	5/8"	7/16"	3/32"	Am/Std, Central, Gerber
271 N 010	10	11/16"	1/2"	3/32"	Dishmaster, Eljer, Indiana
271 N 011	10A	11/16"	9/16"	1/16"	American Standard, Harcraft
271 N 012	10H	11/16"	13/32"	9/64"	Crane, Kohler
271 N 013	11	3/4"	9/16"	3/32"	Am/Std, Indiana, Moen
271 N 014	12	13/16"	5/8"	3/32"	Am/Std, Pr/Pf, Speakman
271 N 015	13	7/8"	11/16"	3/32"	Am/Std, Kohler, Speakman
271 N 016	14	15/16"	3/4"	3/32"	Am/Std, Crane, Kohler, Sayco,
271 N 017	15	1"	3/4"	1/8"	Crane,
271 N 018	16	1-1/16"	13/16"	1/8"	Eljer, Moen, Hotpoint
271 N 019	17	15/16"	13/16"	1/16"	Gerber, Harcraft
271 N 020	18	1-1/16"	7/8"	3/32"	Am/Std, Am/Kitchens, Schaible
271 N 021	19	1-1/8"	15/16"	3/32"	Eljer
271 N 022	20	1-1/8"	7/8"	1/8"	Am/Std, Moen, Sterling, Tracy
271 N 023	21	1-3/16"	15/16"	1/8"	Speakman, Wolverine
271 N 024	22	7/8"	3/4"	1/16"	Kohler
271 N 025	23	1-1/16"	15/16"	1/16"	American Standard, Kohler
271 N 026	24	1-3/16"	1-1/16"	1/16"	American Standard
271 N 027	25	37/64"	19/64"	9/64"	Eljer Lusterline
271 N 028	26	1-1/4"	1-1/8"	1/16"	Delta (old style)
271 N 029	27	1-3/8"	1-1/8"	1/8"	Am/Std, Moen (old style)
271 N 030	28	1-5/16"	1-1/8"	3/32"	Sterling, Symmons
271 N 031	29	1-7/16"	1-5/16"	1/16"	Moen (new style)
271 N 032	30	1-5/16"	1-1/16"	1/8"	Wolverine
271 N 033	31	1-1/2"	1-1/4"	1/8"	Moen, Peerless
271 N 034	32	9/16"	5/16"	1/8"	Crane (Magiclose)
271 N 035	33	1-5/16"	1-3/16"	1/16"	Moen (new style)
271 N 036	34	9/16"	7/16"	1/16"	Graning, Harcraft, Pr/Pfister
271 N 037	35	9/32"	5/32"	1/16"	Thrush
271 N 038	36	1-1/4"	1"	1/8"	Am/ Std, Delta, Speakman
271 N 039	44	USE 271N009			
271 N 040	45	USE 271N012			
271 N 041	46	5/8"	1/2"	5/64"	Acorn, Delta Diverter
271 N 042	47	1-1/2"	1-5/16"	3/32"	Delta, Peerless
271 N 043	38	1-13/16"	1-5/8"	3/32"	RC2 cart., Sloan
271 N 044	40	1"	13/16"	3/32"	Crane, Valley
271 N 045	41	1-3/4"	1-35/64"	7/64"	Nile, Peerless, Valley
271 N 046	42	USE 271N072			
271 N 047	USE 271N014				
271 N 048	48	1"	7/8"	1/16"	Acorn, Harcraft, Valley
271 N 049	49	1-5/8"	1-7/16"	3/32"	Bradley, Cole
271 N 050	USE 271N073				
271 N 051	USE 271N084				
271 N 052	50	1-7/8"	1-11/16"	3/32"	Crane, Kohler
271 N 053	51	13/16"	11/16"	1/16"	Chicago, Delex, Moen

CAT NO.	NO:	O.D.	I.D.	Thick:	Fits (partial listing only):
271 N 054	52	1/4"	1/8"	1/16"	Century, Honeywell
271 N 055	53	7/16"	1/4"	1/8"	Various
271 N 056	54	1/2"	1/4"	1/8"	Various
271 N 057	55	1/2"	5/16"	3/32"	Various
271 N 058	56	3/4"	1/2"	1/8"	Various
271 N 059	57	3/4"	5/8"	1/16"	Various
271 N 060	58	5/8"	3/8"	1/8"	Various
271 N 061	59	11/16"	7/16"	1/8"	Am/Std, Price Pfister
271 N 062	60	2-7/16"	2-1/4"	3/32"	Various
271 N 063	61	13/16"	9/16"	1/8"	Various
271 N 064	62	7/8"	5/8"	1/8"	Various
271 N 065	63	15/16"	11/16"	1/8"	Various
271 N 066	65	1-1/8"	1"	1/16"	Various
271 N 067	66	1-3/16"	1"	3/32"	Various
271 N 068	67	1-1/4"	1-1/16"	3/32"	Various
271 N 069	68	1-3/8"	1-3/16"	3/32"	Sloan Flushometer
271 N 070	69	1-3/8"	1-1/4"	1/16"	Various
271 N 071	70	1-7/16"	1-1/4"	3/32"	Various
271 N 072	71	1-1/2"	1-3/8"	1/16"	Nile
271 N 073	72	1-9/16"	1-5/16"	1/8"	Moen
271 N 074	73	1-5/8"	1-3/8"	1/8"	Various
271 N 075	75	1-5/8"	1-1/2"	1/16"	Speakman
271 N 076	76	1-11/16"	1-7/16"	1/8"	Various
271 N 077	77	1-11/16"	1-1/2"	3/32"	Various
271 N 078	78	1-9/16"	1-3/8"	3/32"	Various
271 N 079	79	1-3/4"	1-1/2"	1/8"	Various
271 N 080	80	USE 271N045			
271 N 081	81	1-3/4"	1-5/8"	1/16"	Moen, Speakman
271 N 082	82	1-7/8"	1-5/8"	1/8"	Various
271 N 083	84	1-7/8"	1-3/4"	1/16"	Briggs/Case, Powers
271 N 084	85	2"	1-5/8"	3/16	Various
271 N 085	86	2"	1-3/4"	1/8"	Kohler
271 N 086	87	2-3/16"	1-31/32"	7/64"	American Standard
271 N 087	83	USE 271N096			
271 N 088	88	2-1/8"	2"	1/16"	Various
271 N 089	USE 271N060				
271 N 093	90	2-1/8"	1-3/4"	3/16"	Franklin/Keil Wastes
271 N 096	96	2-11/64"	1-59/34"	1/8"	American Standard
271 N 098	USE 271N067				
271 N 099	USE 271N067				
271 N 100	100	13/16"	5/8"	3/32"	Quad ring -Speakman
271 N 101	101	15/32"	9/32"	3/32"	Moen
271 N 102	102	1/2"	7/16"	1/64"	Cross Handles
271 N 115	USE 271N053				
271 N 116	116	11/16"	9/16"	1/16"	Chicago
921 S 057	121	1/4"	1/8"	1/8"	Quad Ring - Sloan

271N090, 271N091, 271N092, 271N095, and 271N094 are assortments. See details for these kits on page 1-16.

271N054 #52	921S057 #121	271N037 #35	271N002 #2	271N003 #3	271N005 #5	271N006 #6	271N055 #53	271N102 102	271N004 #4	271N057 #55	271N056 #54	271N036 #34	271N008 #8	271N034 #32
271N027 #25	271N001 #1	271N041 #46	271N009 #9	271N060 #58	271N039 #44	271N011 #10A	Fisher Spout (1600-5000)							

Sizing Guide continues on next pages...



INDIVIDUAL PARTS / FAUCET REPAIRS

CREST/GOOD BUNA-N O-RINGS (shown actual size)

Smaller sizes
are shown on
previous page.

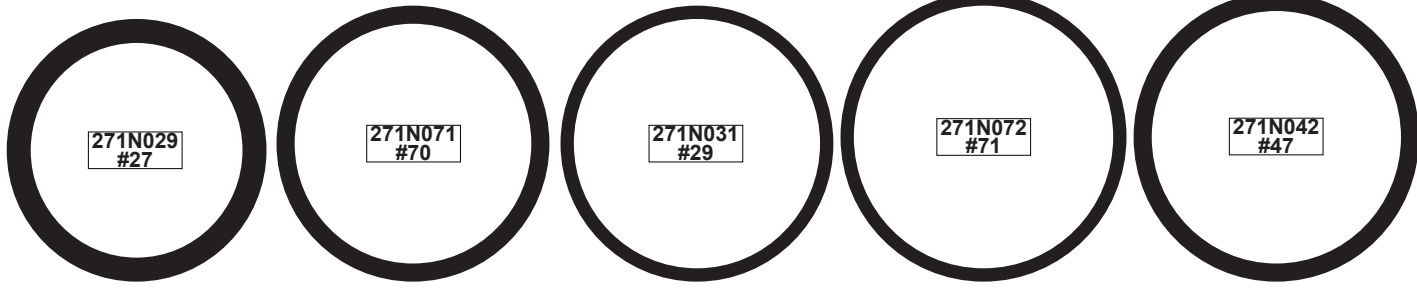
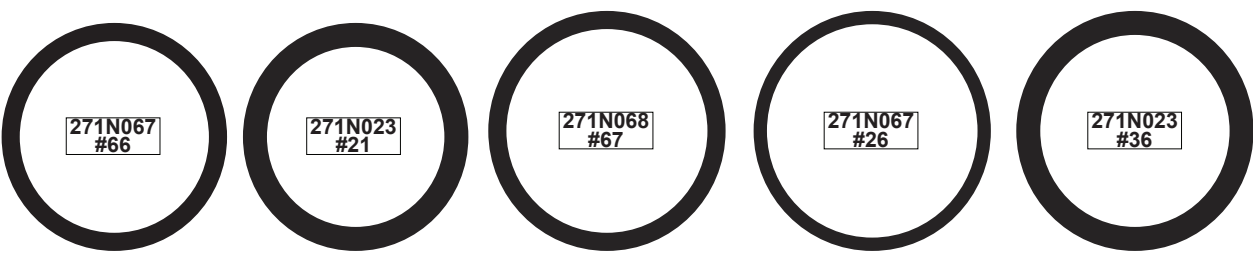
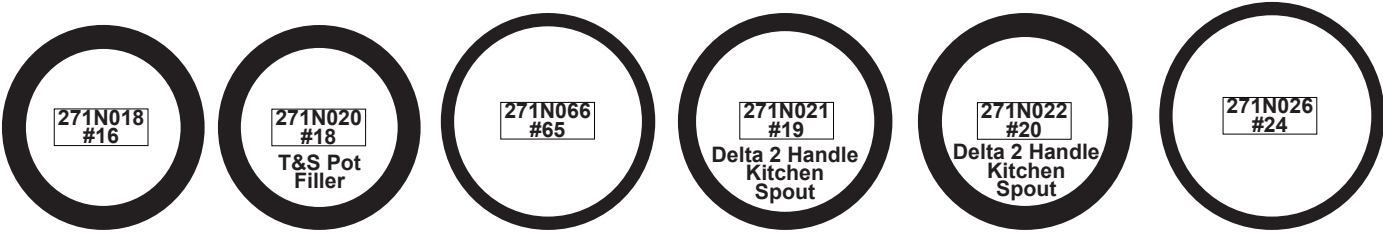
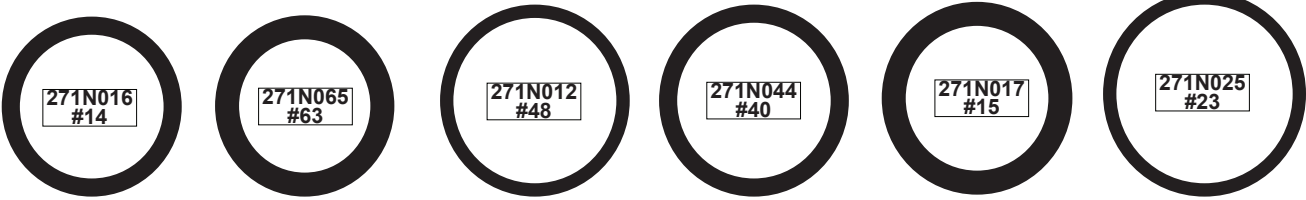
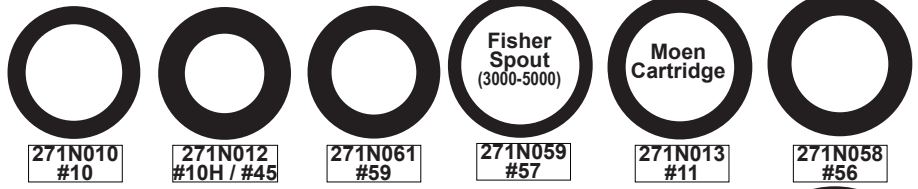

INDIVIDUAL PARTS / FAUCET REPAIRS

CREST/GOOD BUNA-N O-RINGS (shown actual size)

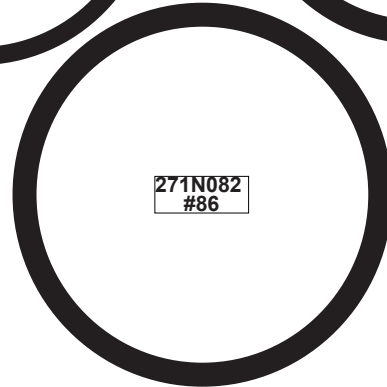
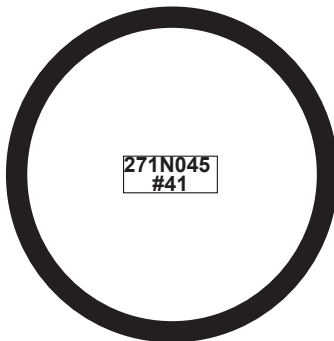
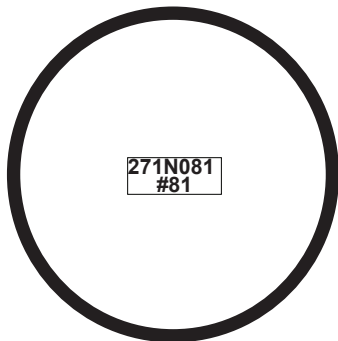
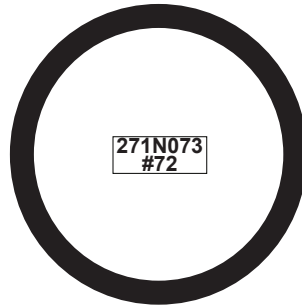
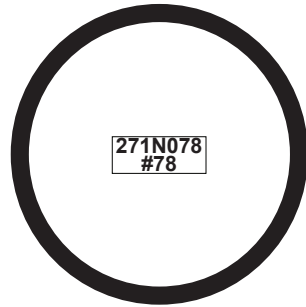

Key Grease
In plastic flip-top
containers.

CAT NO. Size:
843-004 1/2 oz.
843-005 2 oz.



INDIVIDUAL PARTS / FAUCET REPAIRS

CREST/GOOD BUNA-N O-RINGS (shown actual size)

Smaller sizes are shown on previous pages.



271N096
#96

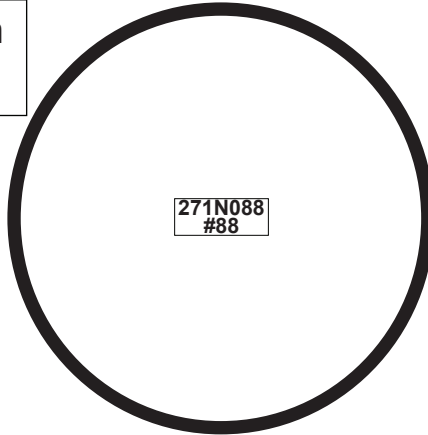

271N088
#88



271N096
#87



271N093
#90

Franklin Waste



271N062
#60

WORKING MAN'S O-RING ASST.

18 different sizes -- 200 total O-Rings, packaged in an unbreakable organizer box. Full sized sizing chart included on the inside of the cover. 8.25" x 4-1/2" x 1-1/4"

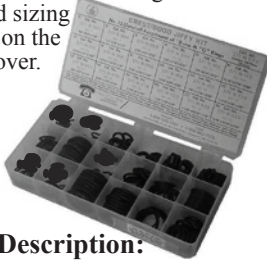

CAT NO. Description:
271N094 #15 O-Ring Assortment

MEDIUM O-RING ASST.

44 different sizes -- 235 total O-Rings, packaged in 50 plastic boxes, all packed in a handy metal carry case. Full sized sizing chart included on the inside of the cover. 11-1/2" x 4-1/2" x 2"



CAT NO. Description:
271N091 #19 O-Ring Assortment K

SMALL O-RING ASST.

33 different sizes -- 116 total O-Rings, packaged in 25 plastic boxes, all packed in a handy metal carry case. Full sized sizing chart included on the inside of the cover. 11-1/2" x 4-1/2" x 2"



CAT NO. Description:
271N090 #16 O-Ring Assortment Kit

LARGE O-RING ASST.

67 different sizes -- 423 total O-Rings, packaged in 69 plastic boxes, all packed in a handy Crestolac® carry case. Full sized sizing chart included on the inside of the cover.

17-1/2" x 7-3/4" x 2-1/2"

our best seller!



INCLUDES O-RING PICK

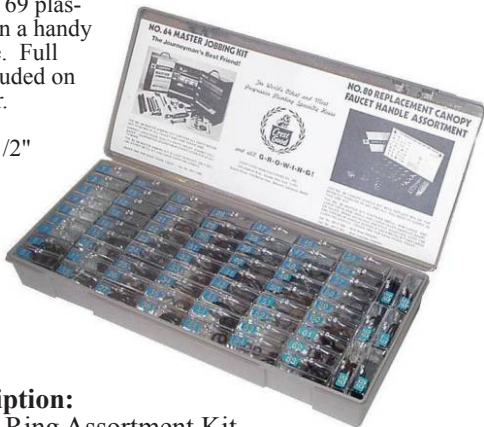

CAT NO. Description:
271N095 #21 O-Ring Assortment Kit

JUMBO O-RING ASST.

The most extensive and complete O-Ring kit available on the market today. 80 different sizes -- 737 total O-Rings, packaged in 100 plastic boxes, all packed in a handy metal carry case. Full sized sizing chart included on the inside of the cover. 17" x 11" x 2-1/2"

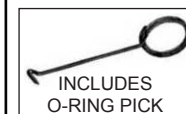

INCLUDES O-RING PICK

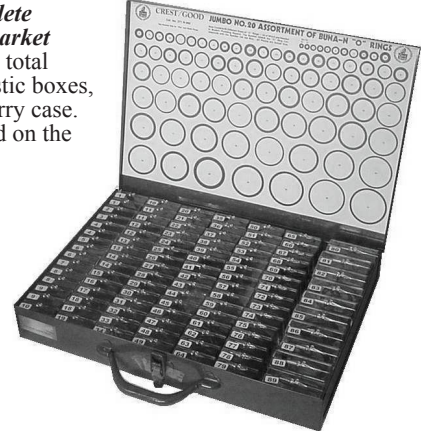



CAT NO. Description:
271N092 #20 O-Ring Assortment Kit



INDIVIDUAL PARTS / FAUCET REPAIRS

INTEGRATED VACUUM BREAKER REPAIR KITS

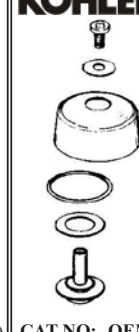
<p>American Standard</p>  <p>AS80: (all parts) (66501) AS81: (67651)</p> <p>CAT NO: OEM: AS80 66501</p>	<p>American Standard</p>  <p>CAT NO: OEM: AS82 M961107</p>	<p>CHICAGO FAUCETS</p> <p>(Kit includes poppet, gasket, & screws. This kit discontinued in 2010)</p>  <p>CAT NO: CF40 (replaced by CF42)</p>	<p>CHICAGO FAUCETS</p> <p>(Kit includes poppet, gasket, screws, & plastic guide. This kit discontinued in 2010)</p>  <p>CAT NO: OEM: CF41 892-202 (replaced by CF42)</p>	<p>CHICAGO FAUCETS</p> <p>In 2010, Chicago changed their Vacuum Breaker assembly to the CF42 kit (oem 892-302,) which features a single screw on the top of the cap and new style insert. The single screw allows the top to spin freely to avoid vandalism. The new CF42 kit will retrofit all earlier Chicago Faucet vacuum breakers.</p>  <p>CAT NO: OEM: CF42 892-302 CF43 892-254 (new style cover with one screw) CF44 892-402 (Cover, screw, and gasket & insert)</p>	<p>CF44</p>  <p>CF43 CF42</p>	<p>CRESTLINE</p> <p>(This kit also repairs pre-1999 SPEAKMAN brand mop sink faucets.)</p>  <p>CAT NO: CT80</p>
---	--	--	--	---	---	--

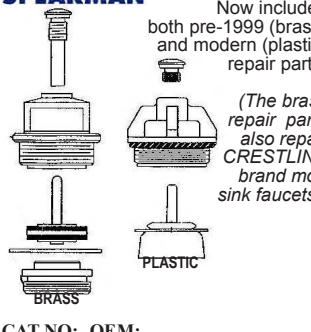
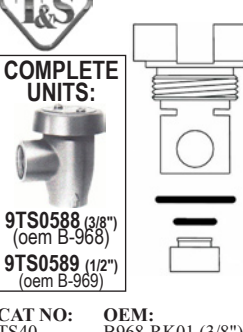
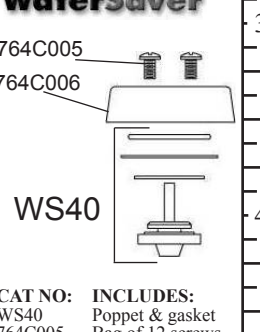
<p>FISHER</p>  <p>CAT NO: OEM: FS40 2932-8001 (3/8") FS41 3990-8001 (1/2")</p>	<p>KOHLER</p>  <p>CAT NO: OEM: KO80 30253</p>	<p>MOEN</p>  <p>(Kit includes metal cover and screw (shown,) and plastic guide, wrench and poppet (not shown.)</p> <p>CAT NO: OEM: MO40 52012</p>	<p>SPEAKMAN</p> <p>Now includes both pre-1999 (brass) and modern (plastic) repair parts. (The brass repair parts also repair CRESTLINE brand mop sink faucets.)</p>  <p>BRASS PLASTIC</p> <p>CAT NO: OEM: SP40 G05-0520</p>	<p>T&S</p> <p>COMPLETE UNITS:</p>  <p>9TS0588 (3/8") (oem B-968) 9TS0589 (1/2") (oem B-969)</p> <p>CAT NO: OEM: TS40 B968-RK01 (3/8") TS41 B969-RK01 (1/2")</p>	<p>WaterSaver</p>  <p>764C005 764C006 WS40</p> <p>CAT NO: INCLUDES: WS40 Poppet & gasket 764C005 Bag of 12 screws 764C006 Chrome cover only</p>
--	---	---	--	--	---

WATTS® Series 288-C (1/4" - 1") Vacuum Breakers

SIZE:	COMPLETE UNIT:	REPAIR KIT:	PLASTIC BRIDGE:	OEM# 288C..
1/4"	766C001	WT38	766C601	0339977
3/8"	766C002	WT38	766C601	0339985
1/2"	766C003	WT12	766C602	0339980
3/4"	766C004	WT34	766C603	0339990
1"	766C005	WT34	766C603	0340096

766C501 Metal cap ONLY for 1/4" & 3/8" vac. breakers
766C503 Metal cap ONLY for 1/2" vac. breakers
766C504 Metal cap ONLY for 3/4" & 1" vac. breakers
227C034 SCREW ONLY 288 series vacuum breaker covers



Watts repair kits include these 3 parts:

ZURN

AquaSpec
1/2"
VB Repair Kit

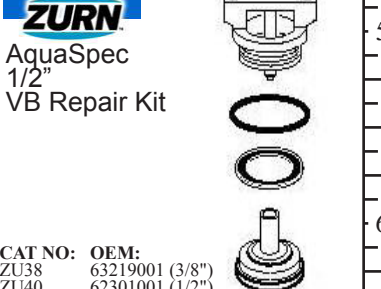



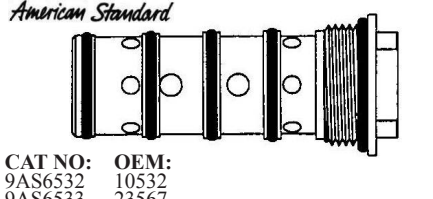
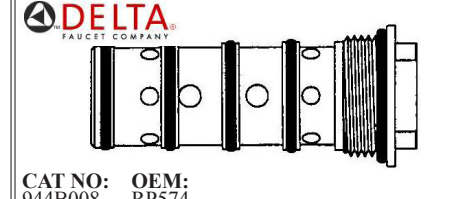
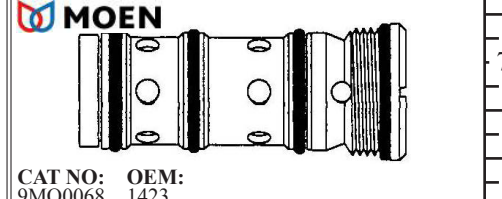

CAT NO: OEM:
ZU38 63219001 (3/8")
ZU40 62301001 (1/2")

BALANCING SPOOLS

<p>American Standard</p>  <p>CAT NO: OEM: 9AS6532 10532 9AS6533 23567</p>	<p>DELTA FAUCET COMPANY</p>  <p>CAT NO: OEM: 944B008 RP574</p>	<p>MOEN</p>  <p>CAT NO: OEM: 9MO0068 1423</p>
---	---	---

UNDER COUNTER MIXING VALVES

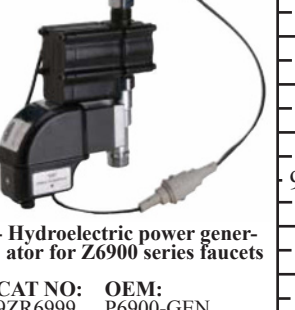
 <p>- Manual adjusting mixer</p> <p>CAT NO: OEM: 9ZR6900 6900-MV</p>	<p>9ZR6504 Single backcheck only</p>  <p>- Non adjustable mixing tee with back checks</p> <p>CAT NO: OEM: 9ZR6901 6900-MT</p>	 <p>- Thermostatic mixing valve (for MULTIPLE faucets)</p> <p>CAT NO: OEM: 9ZR6902 6900-TMV</p>	 <p>- Thermostatic mixing valve (for SINGLE faucets)</p> <p>CAT NO: OEM: 9ZR6903 6900-TMV-1</p>	 <p>- Hydroelectric power generator for Z6900 series faucets</p> <p>CAT NO: OEM: 9ZR6999 P6900-GEN</p>
---	--	---	--	---



INDIVIDUAL PARTS / FAUCET REPAIRS

RENEWABLE FAUCET AND SHOWER SEATS

1	CHROME PLATED BRASS	PLAIN-BRASS	MONEL	SIZE:	DESCRIPTION:	CHROME PLATED BRASS	PLAIN-BRASS	MONEL	SIZE:	DESCRIPTION:		
	CAT NO.	CAT NO.	CAT NO. NO:	(Diam x TPI)		CAT NO.	CAT NO.	CAT NO. NO:	(Diam x TPI)			
	250 C 001	250 K 001	--	AB520	1/2 X 24	American Brass	250 C 064	250 K 064	--	MM4120	1/2 X 27	Milwaukee discontinued
	250 C 002	250 K 002	--	AB521	1/2 X 24	American Brass	250 C 416	250 K 416	--	MM4121	1/2 X 27	Milwaukee discontinued
	250 C 003	250 K 003	--	AB522	9/16 X 20	American Brass	250 C 065	250 K 065	250 M 010	PF4640	5/8 X 18	Price Pfister
	250 C 074	250 K 074	250 M 012	AK220	1/2 X 24	American Kitchens	250 C 066	250 K 066	250 M 011	PF4642	1/2 X 20	Price Pfister
	250 C 006	250 K 006	250 M 001	AS176	35/64 X 24	American Standard	250 C 067	250 K 067	--	RB5220	1/2 X 24	Royal Brass
2	--	--	250 M 023	AS177	7/16 X 24	American Std (aka 250K007)	250 C 068	250 K 068	--	RB5221	5/8 X 20	Royal Brass
	250 C 005	250 K 005	250 M 002	AS177F	7/16 X 24	American Standard	250 C 069	250 K 069	--	RC4830	No thread	Repcal
	250 C 101	250 K 101	--	AS178	7/16 X 24	American Standard	250 C 070	250 K 070	--	RC4831	9/16 X 28	Repcal
	250 C 008	250 K 008	--	AS179	33/64 X 18	American Standard	250 C 129	250 K 129	--	RC4832	35/64 X 18	Repcal
	--	250 K 009	--	AS190	35/64 X 20	American Std (aka SY6035)	250 C 071	250 K 071	--	SB5130	1/2 X 20	Sterling Brass
	250 C 010	250 K 010	--	AS191	13/16 X 24	American Standard	250 C 072	250 K 072	--	SC6920	1/2 X 20	Sayco (aka SC6922)
	250 C 011	250 K 011	--	AS192	33/64 X 18	American Standard	250 C 073	250 K 073	--	SC6921	5/8 X 20	Sayco
	250 C 012	250 K 012	250 M 022	AS193	1/2 X 20	American Standard	250 C 074	250 K 074	250 M 012	SF5320	1/2 X 24	Sterling Faucet (aka AK220)
3	250 C 146	250 K 146	--	AR2012	33/64 X 18	Arrowhead Brass	250 C 075	250 K 075	250 M 020	SP5730	9/16 X 28	Speakman
	250 C 013	250 K 013	--	BA620	9/16 X 24	Barnes	250 C 076	250 K 076	250 M 021	SP5731	7/16 X 27	Speakman
	250 C 014	250 K 014	--	BA621	1/2 X 20	Barnes	250 C 077	250 K 077	--	SP5732	5/8 X 24	Speakman
	250 C 015	250 K 015	--	BA625	7/16 X 27	Barnes	--	--	250 M 119	SP57061	5/8 X 24	Speakman
	250 C 100	250 K 100	--	BE106	1/2 X 27	Belvedere discontinued	250 C 094	250 K 094	--	SR5820	33/64 X 24	Sears (aka SV5924 & UR6412)
	250 C 016	250 K 016	--	BR832	1/2 X 24	Briggs	250 B 009	--	--	SR5821	---	Sears (aka SV5924 & UR6412)
	250 C 017	250 K 017	--	BR834	9/16 X 24	Briggs	250 C 084	250 K 084	--	SV5920	33/64 X 20	Savoy
							250 C 085	250 K 085	--	SV5921	1/2 X 20	Savoy
4	250 C 018	250 K 018	--	BR835	1/2 X 20	Briggs	--	--	250 M 024	SV5923	43/64 X 24	Savoy (formerly 250K133)
	250 C 019	250 K 019	--	BR836	5/8 X 20	Briggs	250 C 094	250 K 094	--	SV5924	33/64 X 24	Savoy (aka SR5820 & UR6412)
	250 C 020	250 K 020	--	BR837	9/16 X 20	Briggs	250 C 132	250 K 132	--	SW6000	1/2 X 24	Streamway
	250 C 022	250 K 022	--	CB1124	5/8 X 24	Central Brass	250 C 135	250 K 135	--	SW6003	1/2 X 24	Streamway
	250 C 023	250 K 023	--	CB1125	5/8 X 24	Central Brass discontinued	250 C 079	250 K 079	250 M 013	SY6020	1/2 X 20	Sayco
	250 K 147			CB 263D	1/2 X 24	Central Brass	250 C 012	250 K 012	250 M 022	SY6026	1/2 X 20	Sayco
	250 C 024	250 K 024	250 M 005	CB1126	1/2 X 24	Central Brass	250 C 082	250 K 082	--	SY6027	1/2 X 20	Sayco
	250 C 108	250 K 108	--	CB1128	1/2 X 24	Central Brass	--	250 K 009	--	SY6035	35/64 X 20	Sayco (aka AS190)
	250 C 025	250 K 025	--	CS1330	3/8 X 24	Chicago Specialty	TS20F	--	--	TS6120	5/8 X 27	T&S Brass
5	250 C 026	250 K 026	--	CS1331	7/16 X 24	Chicago Specialty	250 C 089	250 K 089	--	UB6321	33/64 X 18	Union Brass
	250 C 027	250 K 027	--	CS1332	1/2 X 27	Chicago discontinued	250 C 092	250 K 092	--	UB6322	1/2 X 18	Union Brass
	250 C 028	250 K 028	--	CS1333	9/16 X 27	Chicago Specialty	250 C 090	250 K 090	--	UB6323	1/2 X 18	Union Brass
	250 C 029	250 K 029	--	CS1334	5/8 X 27	Chicago Specialty	250 C 093	250 K 093	--	UB6324	5/8 X 18	Union Brass
	250 C 030	250 K 030	--	CR1640	7/16 X 27	Crane	250 C 091	250 K 091	--	UB6325	1/2 X 18	Union Brass
	250 C 031	250 K 031	--	CR1641	35/64 X 24	Crane	250 C 127	250 K 127	--	UB6327	5/8 X 18	Union Brass
	250 C 032	250 K 032	--	CR1642	35/64 X 22	Crane	250 C 094	250 K 094	--	UR6412	33/64 X 24	Un/Rund(aka SV5924 & SR5820)
6	250 C 112	250 K 112	--	CR1644	11/16 X 22	Crane	250 C 098	250 K 098	--	WB6724	7/16 X 24	Wolverine Brass
	250 C 113	250 K 113	--	CR1645	11/16 X 22	Crane discontinued	250 C 095	250 K 095	--	WB6725	1/2 X 24	Wolverine Brass
	250 C 036	250 K 036	--	CR1646	9/16 X 22	Crane	250 C 096	250 K 096	--	WB6726	19/32 X 24	Wolverine Brass
	250 C 129	250 K 129	--	CR1669	35/64 X 18	Crane						
	250 C 034	250 K 034	--	CR1670	9/16 X 18	Crane						
	250 C 038	250 K 038	--	DB1520	1/2 X 27	Dick Brothers discontinued						
	250 C 039	250 K 039	--	DB1521	35/64 X 27	Dick Brothers						
	250 C 041	250 K 041	--	EJ2130	1/2 X 27	Eljer						
7	250 C 042	250 K 042	--	EJ2131	1/2 X 27	Eljer						
	250 C 040	250 K 040	--	EJ2133	1/2 X 20	Eljer						
	250 C 044	250 K 044	--	EJ2146	35/64 X 27	Eljer						
	250 C 048	250 K 048	--	GB2520	5/8 X 20	Gerber						
	250 C 050	250 K 050	--	HA3127	9/16 X 20	Harcraft						
	250 C 051	250 K 051	--	HA3128	3/4 X 20	Harcraft discontinued						
	250 C 052	250 K 052	--	IB3331	1/2 X 27	Indiana Brass						
8	250 C 053	250 K 053	--	IB3332	9/16 X 27	Ind. Brass discontinued						
	250 C 054	250 K 054	--	KO3530	5/8 X 27	Kohler						
	250 C 125	250 K 125	--	KO3533	1/2 X 27	Kohler						
	250 C 115	250 K 115	--	KO3534	11/16 X 27	Kohler						
	250 C 056	250 K 056	250 M 008	KO3535	1/2 X 27	Kohler						
	250 C 057	250 K 057	--	KO3536	9/16 X 20	Kohler						
	250 C 058	250 K 058	--	KO3537	11/16 X 20	Kohler						
	250 C 059	--	--	KO3538	No thread	Kohler						
9	250 C 060	250 K 060	--	KO3539	5/8 X 27	Kohler						
	250 C 145	250 K 145	--	MB4240	1/2 X 20	Michigan Brass						
	250 C 061	250 K 061	--	MC3030	5/8 X 27	A.Y.McDonald						
	250 C 062	250 K 062	--	MC3931	33/64 X 24	A.Y.McDonald						
	250 C 063	250 K 063	--	MC3932	5/8 X 27	A.Y.McDonald						

FAUCET SEAT SELECTOR

Selector is made of precision-tooled aluminum. Includes 20 specially tapped seat thread sizes, plus 4 common thread tap sizes. This is the selector is preferred by plumbers out on the job in determining the new seat that will replace the worn seat.

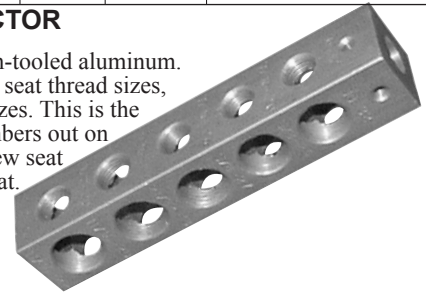

CAT NO.
591 I 091

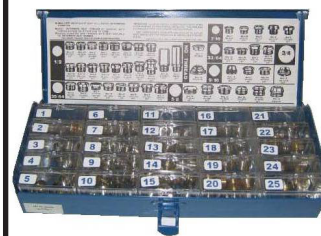

BOXED SEAT ASSORTMENTS ARE ON PAGE 1-23



INDIVIDUAL PARTS / FAUCET REPAIRS

3/8

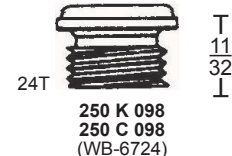
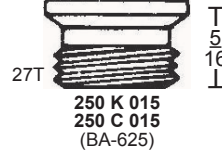
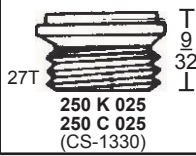

7/16

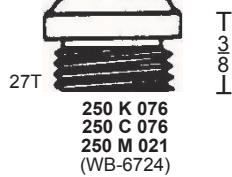
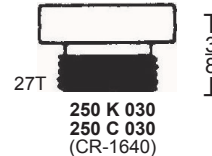
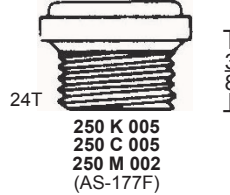
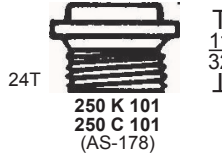

ALL SEATS ON THIS PAGE ARE SHOWN ACTUAL SIZE.

1/2

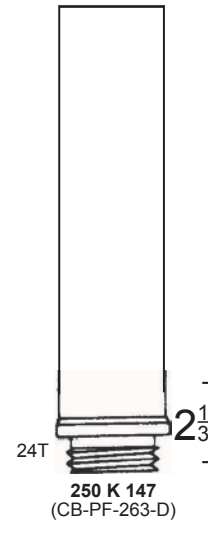
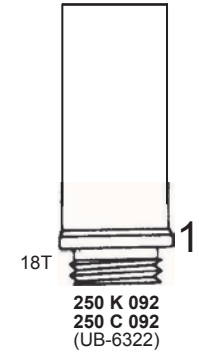
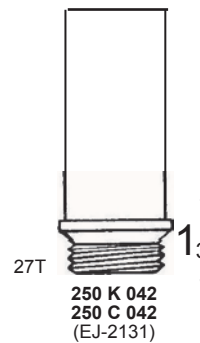
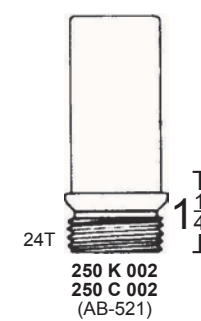
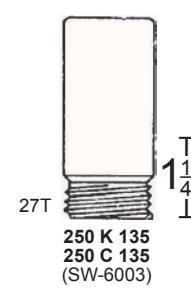
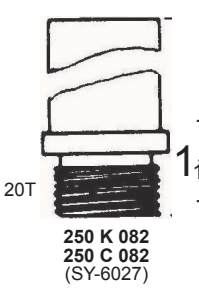
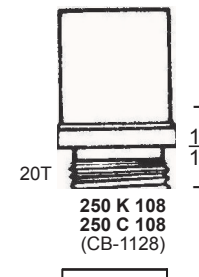
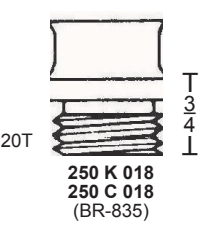
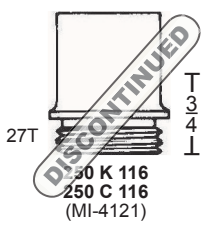
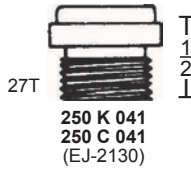
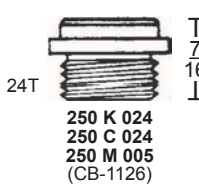
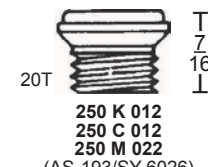
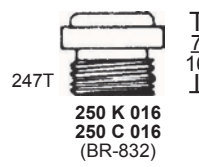
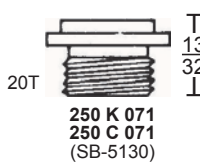
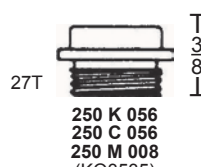
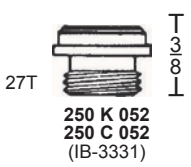
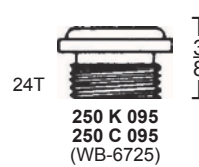
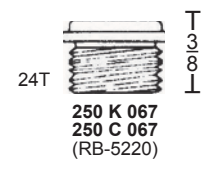
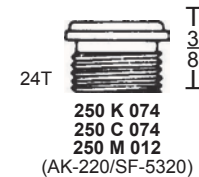
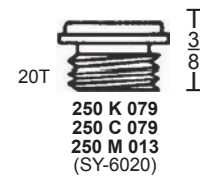
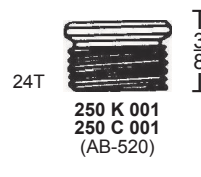
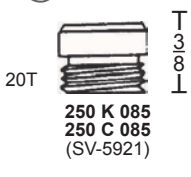
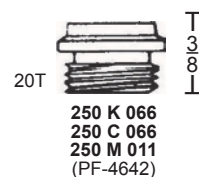
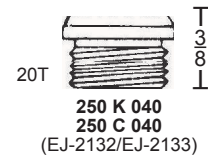
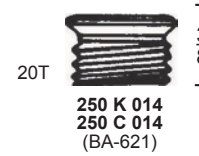
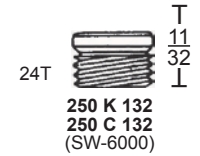
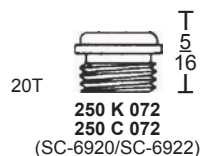
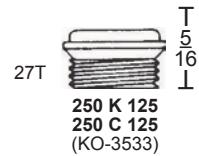
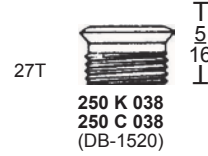
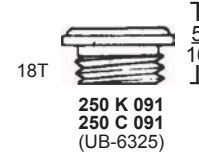
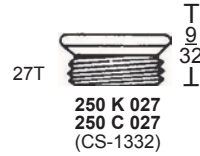
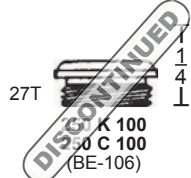



INDIVIDUAL PARTS / FAUCET REPAIRS

RENEWABLE FAUCET AND SHOWER SEATS

1
2
3
4
5
6
7
8
9

33/64

24T

 250 K 094
 250 C 094
 (UR-6412)
 (SR-5820)
 (SV-5924)

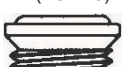
18T

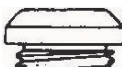
 250 K 008
 250 C 008
 (AS-179)

27T

 250 K 011
 250 C 011
 (AS-192)

27T

 250 K 084
 250 C 084
 (SV-5920)

Plumber's Helper:
 3/64 -18T seats
 fit snugly into
 1/4" FPT fittings.

18T

 250 K 146
 250 C 146
 (AR-2012)

27T

 250 K 089
 250 C 089
 (UB-6321)

notes:





35/64

24T

 250 K 006
 250 C 006
 250 M 001
 (AS-176)

20T

 250 K 009
 (rubber face)
 (AS-190)

22T

 250 K 032
 250 C 032
 (CR-1642)

24T

 250 K 062
 250 C 062
 (MC-3931)

27T

 250 K 039
 250 C 039
 (DB-1521)

18T

 250 K 129
 250 C 129
 (CR-1669)
 (RC-4832)

24T

 250 K 031
 250 C 031
 (CR-1641)

X NO THREAD

27T

 250 K 044
 250 C 044
 (EJ-2146)

250 K 069
 250 C 069
 (RC-4830)

250 K 059
 250 C 059
 (KO-3538)

9/16

20T

 250 K 003
 250 C 003
 (AB-522)

27T

 250 K 028
 250 C 028
 (CS-1333)

20T

 250 K 057
 250 C 057
 (KO-3536)

28T

 250 K 070
 250 C 070
 (RC-4831)

24T

 250 K 017
 250 C 017
 (BR-834)

28T

 250 K 075
 250 C 075
 250 M 020
 (SP-5730)

20T

 250 K 020
 250 C 020
 (BR-837)

24T

 250 K 013
 250 C 013
 (BA-620)

24T

 250 K 096
 250 C 096
 (WB-6726)

20T

 250 K 050
 250 C 050
 (HA-3127)

18T

 250 K 034
 250 C 034
 (CR-1670)

22T

 250 K 036
 250 C 036
 (CR-1646)

DISCONTINUED

27T

 250 K 053
 250 C 053
 (IB-3332)

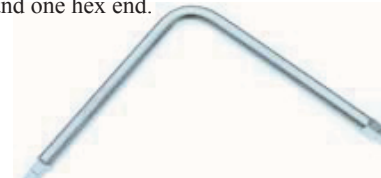
19/32

FIT-ALL ANGLE SEAT WRENCH
 Fits most seats. Features one squared, and one hex end.



CAT NO. 591 I 001 DESCRIPTION Angle Seat Wrench



INDIVIDUAL PARTS / FAUCET REPAIRS

RENEWABLE FAUCET AND SHOWER SEATS

5/8

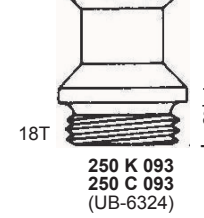
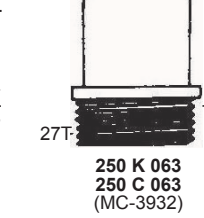
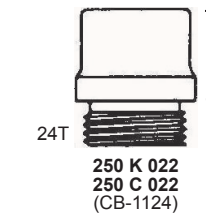
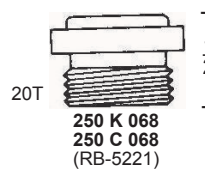
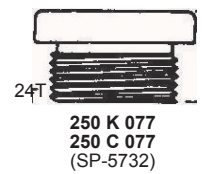
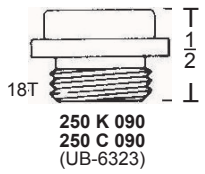
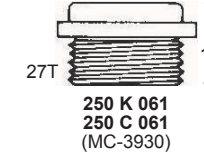
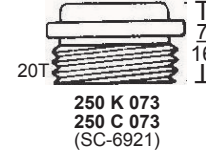
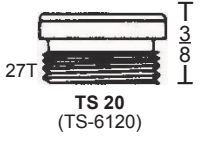
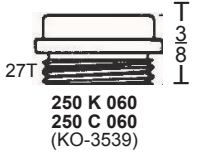
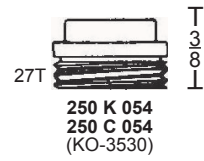
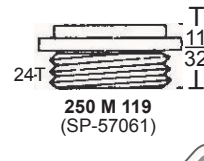
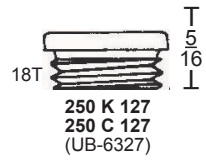
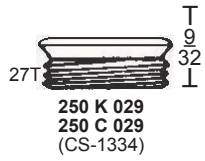

43/64

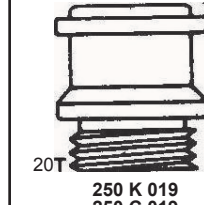
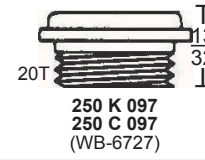
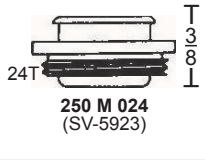

11/16

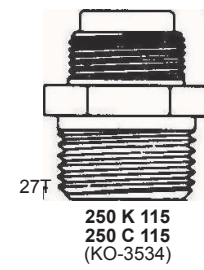
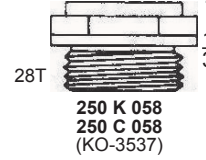
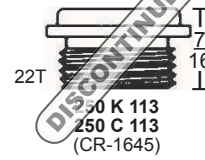
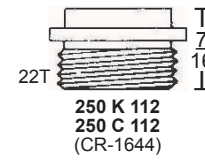

SEATS ARE SHOWN ACTUAL SIZE.

3/4

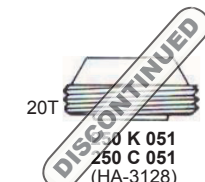

13/16

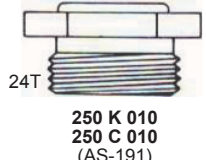



notes:

RATCHET SEAT EXTRACTOR SET

Heavy-duty 1/2" ratchet with removal tools.



- | CAT NO. | DESCRIPTION |
|-----------|---|
| 591 I 092 | 3 pc set (square, hex, and ratchet) |
| 591 I 094 | 4 pc set (square, hex, and ratchet, plus "The Extractor.") |
| 591 I 078 | Hex wrench only  |
| 591 I 079 | Square wrench only  |
| 591 I 080 | The Extractor only  |
| 591 I 093 | Ratchet wrench only  |

-  This tool for square seats.
-  This tool for hex seats.
-  This tool for worn out seats.



INDIVIDUAL PARTS / FAUCET REPAIRS

RENEWABLE FAUCET AND SHOWER SEATS

AMERICAN STANDARD RENEWABLE BARRELS

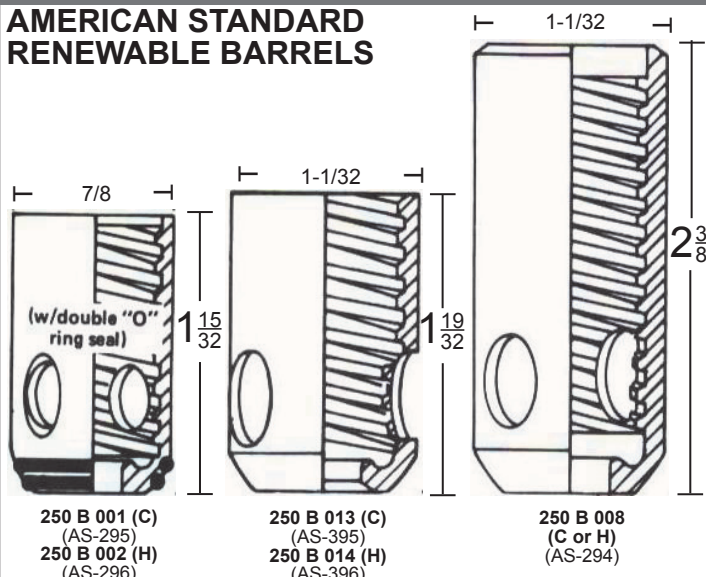

KOHLER RENEWABLE SEATS & BARRELS

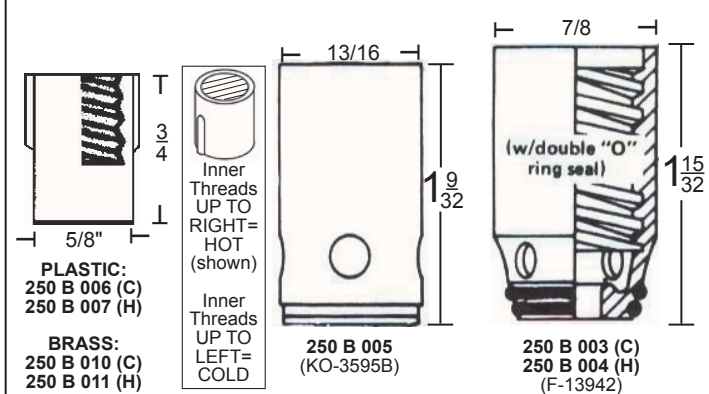

PRICE / PFISTER RENEWABLE SEAT

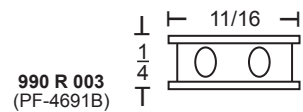

CRANE DIAL-ESE SEAT EXTENSIONS

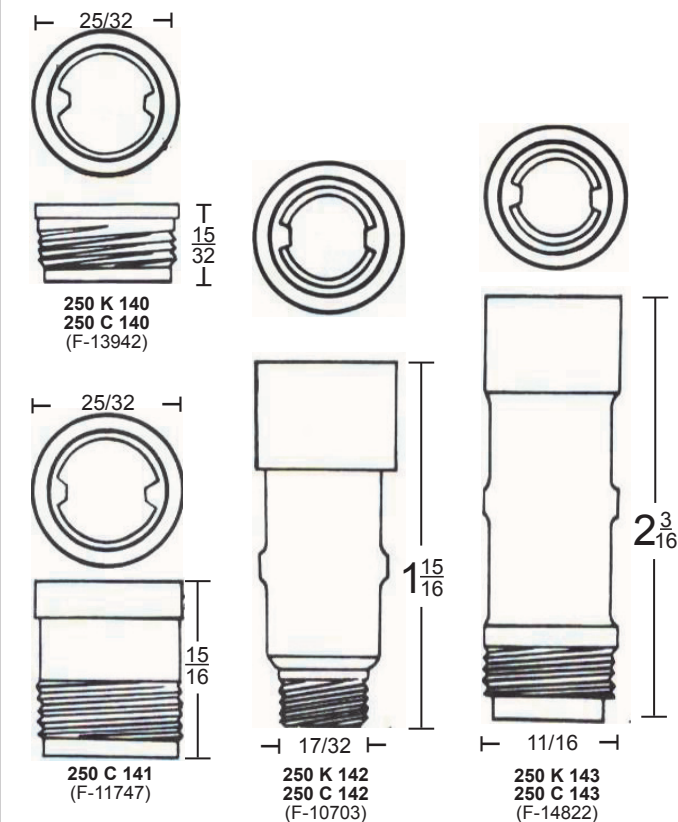

SEARS / UNIVERSAL RUNDLE RENEWABLE SEAT

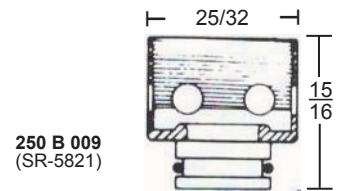

SYMMONS RENEWABLE SEATS (NOT shown actual size)

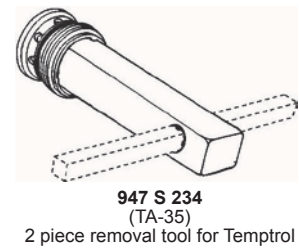
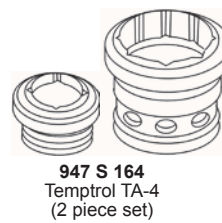

Notes:



T&S BRASS REPLACEMENT BARRELS (NOT shown actual size)

More information on this stem is found on page 2-239.

TS64L Hot Barrel only
TS66L Cold Barrel only

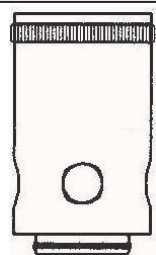

INDIVIDUAL PARTS / FAUCET REPAIRS

FAUCET AND SHOWER SEAT ASSORTMENTS

JUMBO Sink, Lav, and Bath Seat Assortment

100 different sizes for more than 37 manufacturers. Housed in a metal carry container with 100 individual plastic boxes for quick visible identification. No overstocking, no mess. Over 350 total seats in all. Handy real-size identification chart included on inside of box cover.

Box dim: 17" x 14" x 2.5"

CAT NO.
250-096 (#23)



LARGE Sink, Lav, and Bath Seat Assortment

73 different sizes, covering more than 30 manufacturers. Housed in a metal carry container with 50 individual plastic boxes for quick visible identification. Over 150 total seats in all. Real size identification chart included inside box cover.

Box dim:
12" x 8" x 2.25"

CAT NO.
250-094 (#22)
250-095 (#22W) (with 3 pc seat wrench kit, shown below)

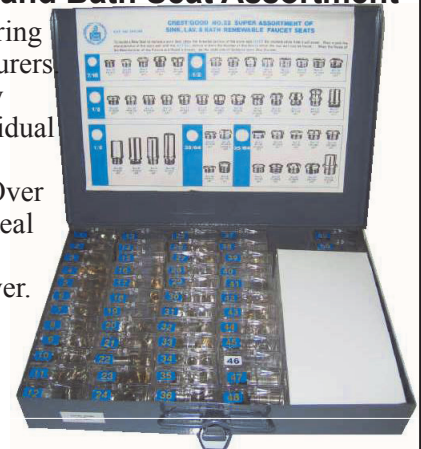

MEDIUM Sink and Lav Seat Assortment

45 different sizes, covering more than 45 manufacturers. In a metal container with 25 individual plastic boxes for quick visible identification. Over 105 total seats. Real-size ID chart included inside of box.

Box dim:
12" x 4" x 2.25"

CAT NO.
250-090 (#13) Seat kit, less wrenches
250-091 (#13W) Seat kit, with wrench kit



MEDIUM Bath and Shower Seat Assortment

26 different sizes, covering more than 30 manufacturers. In a metal carry container w/25 individual plastic boxes for quick visible identification. 62 total seats in all. Real-size identification chart included inside of box.

Box dim:
12" x 4" x 2.25"

CAT NO.
250-092 (#21) Seat kit, less wrenches
250-093 (#21W) Seat kit, with wrench kit

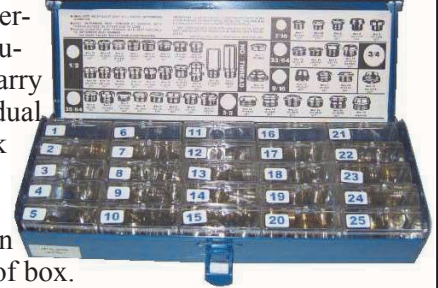

Notes:



SEAT DRESSERS AND REFORMERS

ECONOMY SEAT DRESSER



Faucet seat dresser has three hardened steel cutters for redressing deformed seats.

CAT NO.
554 I 001

ECONOMY SHOWER SEAT DRESSER



Extra long seat dresser for reaching into shower valves, with three hardened steel cutting heads.

CAT NO.
554 I 002

PROFESSIONAL GRADE SEAT DRESSER KIT

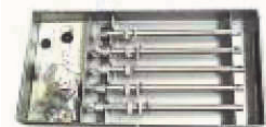

- Kit includes 7/16", 1/2", 9/16" and 5/8" taps. For reseating faucets to 3/4" also 9/16", 5/8" and 3/4".

CAT NO.
554 I 003



INDIVIDUAL PARTS / FAUCET REPAIRS

FAUCET AERATORS

DELUXE SPRING-FLO AERATORS

3 Copper rimmed screens, 1 cup screen, and 1 polyrim provide the best possible filtration.

Extra large air chamber for maximum aeration. Triple chrome plated brass slotted body provides years of corrosion-free use.

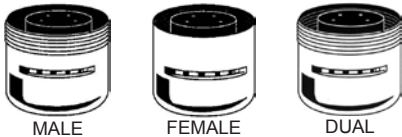
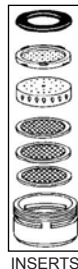

CAT NO.	#:	Size	GPM:
811 C 012	400	15/16 Male	2.2
811 C 011	300	15/16 Female	2.2
811 C 013	500	15/16 Dual	2.2
811 C 003	202	13/16 Male	2.2
811 C 019	302	13/16 Female	2.2

STANDARD INSERT STYLE AERATORS

Triple chrome plated body holds a flow insert that reduces water consumption regardless of line pressure.



Slotless, unless noted.



CAT NO.	#:	Size	GPM:
811 C 026	404	15/16 Male	2.2
811 C 028	414	15/16 Female	2.2
811 C 014	600	15/16 Dual	2.2
811 C 113	601	15/16 Dual (slots)	2.2
811 C 031	474	13/16 Male	2.2
811 C 032	475	13/16 Female	2.2

811 C 130		15/16 Male	1.5
811 C 131		15/16 Female	1.5
811 C 114		15/16 Dual	1.5
811 C 133		13/16 Male	1.5
811 C 134		13/16 Female	1.5

811 C 001		15/16 Male	1.0
811 C 010		15/16 Female	1.0
811 C 005		15/16 Dual	1.0
811 C 007		13/16 Male	1.0
811 C 046		13/16 Female	1.0

811 C 047		15/16 Male	.5
811 C 048		15/16 Female	.5
811 C 049		15/16 Dual	.5
811 C 050		13/16 Male	.5
811 C 051		13/16 Female	.5

VANDAL RESISTANT AERATORS

Triple chrome plated body has outer sleeve that spins freely while threaded insert holds tight to faucet. Each box of 6 includes VP key. Additional keys sold separately.

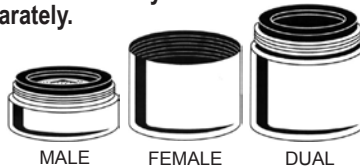
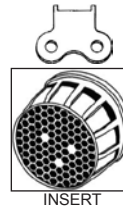

CAT NO.	Size	GPM:
811 C 027	15/16 Male	1.5
811 C 029	15/16 Female	1.5
811 C 068	13/16 Male	1.5
811 C 074	13/16 Female	1.5
811 C 060	15/16 Male	1.0
811 C 061	15/16 Female	1.0
811 C 062	13/16 Male	1.0
811 C 064	13/16 Female	1.0

811 C 020	15/16 Male	.5
811 C 021	15/16 Female	.5
811 C 101	13/16 Male	.5
811 C 025	13/16 Female	.5

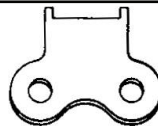

AERATOR KEYS ARE SHOWN ON PAGE 1-27

WHAT'S YOUR AERATOR SIZE?



Quarter hovers over outside threads

15/16 MALE



Nickel fits inside threads

15/16 FEMALE



Nickel hovers over outside threads

13/16 MALE



Dime fits inside threads

13/16 FEMALE

NO-AIR LAMINAR-FLO MODERATORS

Moderators are devices approved by State Health Departments for use in health care facilities where normal aeration of the water stream is undesired. Stream is non-splashing, silent, and clear.

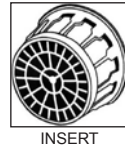

CAT NO.	Size:	GPM:
811 C 035	15/16 Male	2.2
811 C 036	15/16 Female	2.2
811 C 037	15/16 Dual	2.2
811 C 038	13/16 Male	2.2
811 C 039	13/16 Female	2.2
811 C 040	Male (for Chicago female outlet solid spouts)*	
811 C 041	Female (for Chicago male outlet "A" spouts)*	
811 C 057	Male (for Chicago female outlet "B" spouts)*	

811 C 092	15/16 Male	1.5
811 C 093	15/16 Female	1.5
811 C 094	15/16 Dual	1.5
811 C 095	13/16 Male	1.5
811 C 096	13/16 Female	1.5

811 C 140	15/16 Male	.5
811 C 141	15/16 Female	.5
811 C 142	15/16 Dual	.5
811 C 143	13/16 Male	.5
811 C 144	13/16 Female	.5

* 2.2GPM. See page 1-26 to ID Chicago spouts

VANDAL RESISTANT NO-AIR LAMINAR-FLO MODERATORS

As above, but with a vandal resistant sleeve to prevent theft. Includes key.

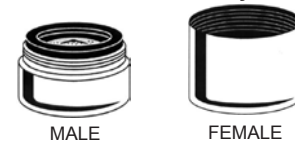

CAT NO.	Inlet Size:	GPM:
811 C 065	15/16 Male	2.2
811 C 067	15/16 Female	2.2
811 C 069	13/16 Male	2.2
811 C 070	13/16 Female	2.2

811 C 071	15/16 Male	1.5
811 C 072	15/16 Female	1.5
811 C 075	13/16 Male	1.5
811 C 079	13/16 Female	1.5

811 C 150	15/16 Male	.5
811 C 151	15/16 Female	.5
811 C 152	15/16 Dual	.5
811 C 153	13/16 Male	.5
811 C 164	13/16 Female	.5



INDIVIDUAL PARTS / FAUCET REPAIRS

SPECIALTY AERATORS AND ADAPTERS

TWO PIECE SNAP APART AERATORS

For hooking up portable dishwashers, dialysis units, or other appliances that have 3/4" hose attachments. Both the #701 and #602N adapters are 15/16" dual thread inlet. Both #430 and #630N couplers have 3/4" hose thread outlets.



CAT NO. Description:
 811 C 018 #701 long 15/16 dual aerator
 813 C 013 #602N snap adapter only

813 C 017 #430 hose coupler only
 813 C 014 #630N hose coupler only

811 C 017 #701 / #430 combination
 811 C 016 #602N / 630N combination

GARDEN HOSE

QUICK SNAP COUPLERS ARE SHOWN ON PAGE 7-2

SPRAY AND SWIVEL AERATORS

Fits most kitchen faucets that do not have pull out spray wands.

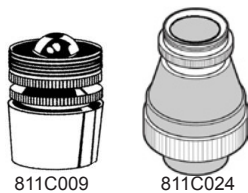

CAT NO. Description:
 811 C 009 15/16 dual swivel aerator
 811 C 024 15/16 dual swivel/spray aerator

INDUSTRY LABEL VS ACTUAL THREAD

15/16 MALE = 15/16" ACTUAL
15/16 FEMALE = 55/64" ACTUAL
13/16 MALE = 13/16" ACTUAL
13/16 FEMALE = 3/4" ACTUAL

GARDEN HOSE INLET AERATORS

For mop sink faucets with hose thread outlets.

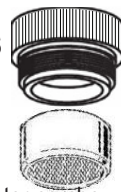

CAT NO. Description:
 811 C 006 Adapter / aerator combo
 813 A 007 Adapter only

AERATOR AND ADAPTER ASSORTMENT



CAT NO. _____
 811 C 090
 (See details on page 1-70.)

ROD ACTUATED AERATORS

For the Medical and food service industries: Reduces cross-contamination and eliminates wasted water. To operate, just press rod back with thumb and wash hands. Eliminates the need to touch faucet handles. Used in over 100,000 restaurants and medical offices. Drastically lowers water cost. Simply replace aerator on any faucet. (Adapters included.)

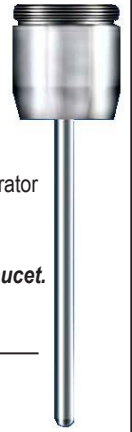

Comes standard with a 3" stainless steel rod. **Choose the 6" Rod option if you have a tall faucet.** (Order VR option for vandal resistant version.)

CAT NO. Description:
 811 C 063 3" Rod Actuator aerator
 811 C 066 6" Rod Actuator aerator
 811 C 073 3" VR Rod Actuator aerator
 811 C 076 6" VR Rod Actuator aerator

INDIVIDUAL AERATOR ADAPTERS

NICKEL PLATED BRASS, UNLESS SPECIFIED. WITH WASHER.

15/16 Dual 3/4 Garden Hose 813 C 004	15/16 Dual 3/4 Garden Hose 15/16 male 813 C 003	3/4 Garden Hose 15/16 male 813 A 007	3/8" MIP 15/16 male 813 C 005	3/8" FIP 15/16 male 813 C 011
5/8-24 male 15/16 male 813 C 007	5/8-18 male 15/16 male 813 C 006	3/4-27 female 15/16 male 813 C 016	13/16-24 female (Chicago faucets) 15/16 male 813 C 009	13/16-27 male 15/16 male 813 C 012
11/16-27 male 15/16 male 813 C 008	21/32-27 male 15/16 male 813 C 010	7/8-27 male PLASTIC 15/16 male 813 P 001	7/8-27 male 15/16 male 813 C 015	ADAPTER ASSORTMENT 811 C 190

CAT NO.	NO:	Inlet:	Outlet:
813A007	K2	3/4 F hose	15/16 male
813C003	103A	15/16 m or f	3/4 F hose & 15/16 male
813C004	103B	15/16 m or f	3/4 F hose
813C005	107AP	3/8 MIP	15/16 male
813C006	108A	5/8-18 male	15/16 male
813C007	109A	5/8-24 male	15/16 male
813C008	110A	11/16-27 male	15/16 male
813C009	111A	13/16-24 female	15/16 male
813C010	112A	21/32-27 male	15/16 male
813C011	120A	3/8 FIP	15/16 male
813C012	122A	13/16-27 male	15/16 male
813C015	705A	7/8-27 male	15/16 male
813P001	705AP	7/8-27 male	15/16 male (plastic)
813C016	125A	3/4-27 female	15/16 male
811C190	969A	Aerator adapter assortment - 17 different sizes; packaged in a hinge top organizer box.	

Use to attach...:
 standard aerator to garden hose outlet
 garden hose to standard spout
 garden hose to standard spout
 standard aerator to 3/8 T&S Brass "S2" spouts
 standard aerator to old Kohler spouts
 standard aerator to old Eljer spouts
 standard aerator to Chicago type "B" spouts
 standard aerator to Chicago type "A" spouts
 standard aerator to old Harcraft spouts
 standard aerator to spouts with 3/8 MIP threads
 standard aerator to 13/16 female spouts
 standard female aerator to 15/16 female spouts
 standard female aerator to 15/16 female spouts
 standard aerator to 13/16 male spouts

Attach a standard 15/16 female aerator to any of these adapters.

