

INDIVIDUAL PARTS / FAUCET REPAIRS

SPECIALTY AERATORS AND ADAPTERS

CHICAGO FAUCETS OEM CHICAGO FAUCET SPECIALTY AERATORS

Chicago faucets use a special "13/16-24" thread on their male (type "A") spouts. Only Chicago brand aerators and moderators will fit this thread. Female (type "B") spouts have 3/8 FIP thread. Solid brass spouts use a standard 13/16 male aerator.

NOTE: FAUCETS WITH SOLID BRASS SPOUTS, LIKE THE 333, 404, AND 802 SERIES, USE A 13/16 MALE AERATOR, (E12 / E2805/ E34).

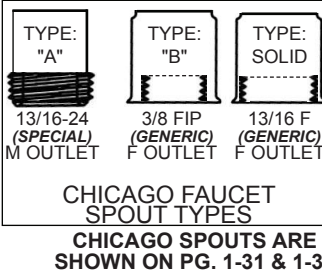

CAT NO.	OEM:	Size	GPM:	Notes:
811C077	E1 JK CP	13/16-24 female	n/a	Single screen outlet (special CF thread)
811C078	E2 JK CP	13/16-24 female	n/a	3/4" garden hose outlet (special CF thread)
811C015	E3 JK CP	13/16-24 female	1.5	(special CF thread)
811T015	E3 JK CP	13/16-24 female	1.5	Non OEM version (special CF thread)
811C080	E3 VP JK CP	13/16-24 female	2.2	Vandal resistant, w/ key (special CF thread)
811C081	E4 JK CP	3/8 IP male	1.5	
811C082	E4F JK CP	3/8 IP female	2.0	
811C003	E12 JK CP	13/16 male	2.2	(standard thread)
811C045	E12VP JK CP	13/16 male	2.2	(standard thread) Vandal resistant, w/ key
811C115	E15 JK CP	13/16 male	2.0	(standard thread)
811C083	E2805-5 JK CP	13/16-24 female	0.5	Vandal resistant, w/ key (special CF thread)
811C084	E2805 JK CP	13/16 male	0.5	Vandal resistant, w/ key
811C085	E29 JK CP	13/16-24 female	2.2	LAMINAR FLOW (special CF thread)
811C086	E34 JK CP	13/16 male	1.5	
811C087	E34VP JK CP	13/16 male	1.5	Vandal resistant, w/ key
811C088	E35 JK CP	13/16-24 female	1.5	(special CF thread)
811C089	E35VP JK CP	13/16-24 female	1.5	Vandal resistant, w/ key (special CF thread)
811C091	K1	13/16-24 female	n/a	adapter to 3/8 FIP (special CF thread)

AERATOR AND ADAPTOR SETS FOR CHICAGO FAUCETS

Save up to 70% over Chicago OEM pricing by combining a #500 aerator (shown on page 1-24) with these special adaptors.

Sold separately or pre-packed with aerator.

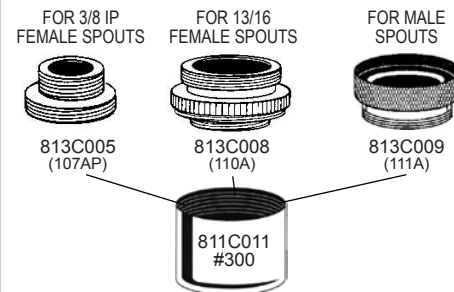

CAT NO.	#:	DESCRIPTION:
813C005	107AP	Adaptor for 3/8 F. spouts
813C008	110A	Adaptor for F. spouts
813C009	111A	Adaptor for M. spouts
811C011	300	#500 Aerator
811C058	799	107AP+ #500 Aerator
811C022	800	110A + #500 Aerator
811C023	801	111A + #500 Aerator

DELTA OEM AERATOR

Genuine Delta Faucet aerator for many Delta faucets.



CAT NO.	OEM:
811C002	RP330 (2.2 aerator)
811C055	RP60729 (.5 insert only)
811C056	RP60983 (1.5 insert only)

WaterSaver AERATOR

Aerator for many Watersaver faucets. 3/8" IP inlet, 2.2 GPM.



CAT NO.	OEM:
811C097	BO 055
811C058	(economy option - see lower left)

WaterSaver EYE WASH

Details shown on page 10-3

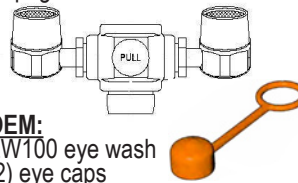

CAT NO.	OEM:
811C098	EW100 eye wash
811C198	(2) eye caps

T&S OEM T&S BRASS SPECIALTY ADAPTERS

T&S Brass Faucets use three different outlet threads on their spouts:

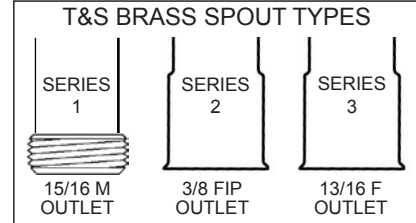

"Series 1" (S1) spouts have a standard 15/16 male outlet. Any 15/16 female aerator will fit these spouts.

"Series 2" (S2) spouts have a 3/8" female outlet. Use a 3/8" male adapter or aerator on these.

"Series 3" (S3) spouts have a standard 13/16" female outlet. Any 13/16" male aerator will fit these spouts.

The adapters shown below are OEM T&S Brass, and can be used on other spouts with the same thread. Likewise, these adapters can be used on other mfrs' spouts with similar threads.

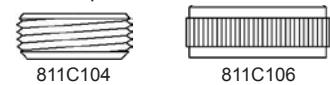

CAT NO.	DESCRIPTION:
811C104	B-GFE Garden hose adp for S1
811C106	B-PT Stream regulator for S1

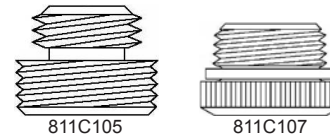

CAT NO.	DESCRIPTION:
811C105	B-GH Garden hose adp for S2
811C107	B-LT Stream regulator for S2

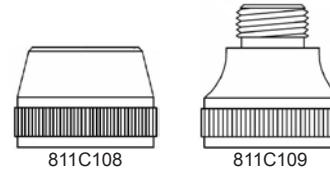

CAT NO.	DESCRIPTION:
811C108	B-0103-01 Rosespray for S1 (4 gpm)
811C109	B-0103 Rosespray for S2 (4 gpm)
811C116	B-0103 Rosespray for S2 (2 gpm)
811C117	B-0103 Rosespray for S2 (1.4 gpm)
811C118	B-0103 Rosespray for S2 (.7 gpm)

SIDE OUTLET AERATORS



CAT NO.	DESCRIPTION:
811C121	with 1/4" side outlet
811C122	with 3/8" side outlet



INDIVIDUAL PARTS / FAUCET REPAIRS

KEYS FOR VANDAL RESISTANT AERATORS

For removing 15/16 vandal resistant aerators shown above. One key included in each box of 6 vandal proof aerators.

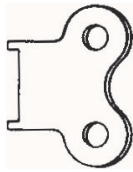

CAT NO. 811 W 001 **Description:** Standard aerator key

CHICAGO FAUCET AERATOR WRENCH

For removing 15/16 AND 13/16 vandal resistant aerators.

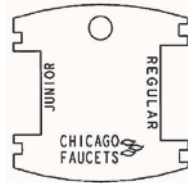

CAT NO. 811 W 005 **Description:** DUAL aerator key

SPECIALTY AERATOR WRENCHES

Specialty aerator removal tools for almost every aerator. The 811W002 removes VP aerators that have two small divots on the bottom. The 811W003 is a two sided tool, that grabs aerators with flat indents on the sides, or on almost any standard aerator.



811W002



811W003

CAT NO. 811W002 **Description:** Starfish aerator tool
CAT NO. 811W003 **Description:** Gripper aerator tool

DELTA FAUCET AERATOR WRENCHES

Designed for use with Delta brand vandal resistant aerators.



TYPE 'A'



TYPE 'B'



TYPE 'C'



INSERT

CAT NO.	OEM#:	Description:	OD:	ID	Notes:	Insert OD:
811W006	RP46245	Large (type 'A') tool only	15/16"	13/16"	Cache Std.	----
811W004	RP46858	Small (type 'A') tool only	7/8"	11/16"	Cache Jr. (same as RP60730)	----
811W004	RP60730	Small (type 'A') tool only	7/8"	11/16"	Delta "Classic" key (same as RP46858)	----
811W007	13-04810	Small (type 'A') tool with 1.5 GPM insert	7/8"	5/8"	(for Delta - fine thread)	3/4"
811W008	13-04510	Small (type 'A') tool with 1.5 GPM insert	7/8"	5/8"	(for Moen - course thread)	3/4"
811W009	RP52217	Small (type 'B') tool only	7/8"	5/8"	(for Delta)	----
811W010	RP50815	Small (type 'B') tool with 1.5 GPM insert	7/8"	5/8"	(for Delta) (same as RP54977)	3/4"
811W010	RP54977	Small (type 'B') tool with 1.5 GPM insert	7/8"	5/8"	(for Delta) (same as RP50815)	3/4"
811W012	RP71111	Small (type 'B') tool with 0.5 GPM insert	7/8"	5/8"	(for Delta)	3/4"
811W013	RP51345	MINI (type 'C') tool with 1.5 GPM insert	5/8"	9/16"	Neoperl Cache TT (for Delta)	5/8"

Notes:



INDIVIDUAL PARTS / FAUCET REPAIRS

Notes:

1

2

3

4

5

6

7

8

9



INDIVIDUAL PARTS / FAUCET REPAIRS

SPRAY HEADS AND FAUCET DIVERTERS

RINSE-QUIK KITCHEN SPRAY

Replacement spray rinse and hose for most generic pull out faucets.



- CAT NO. Description:**
 812X001 Black spray head only, boxed
 812X111 Black spray head only, bagged
 812D002 Black hose only
 812D003 Black head and hose combo
 812X002 White spray head only, boxed
 812D004 White head and hose combo
 812D005 Chrome hose mounting guide

MALE PLUG FOR SPRAY HOSE REMOVAL

When spray hose is no longer needed.

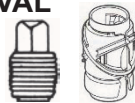

- CAT NO. Description**
 803B002 For most spray hoses
 9DE0336 Snap plug for Delta Faucets (RP40301)

PULL-OUT KITCHEN SPRAY

Replacement spray head for most generic pull out faucets.

Fits Moen, Delta, Price Pfister, and many others.

Available in white or chrome.

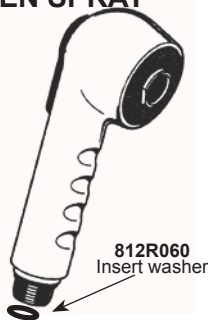

- CAT NO.**
 812D601 Chrome pull out spray head
 812D602 White pull out spray head

OEM HOSES FOR PULL OUT SPRAYS

OEM hoses for various manufacturers.

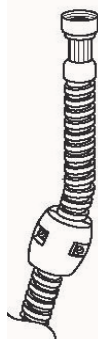

- CAT NO.**
 812 R 060 Hose washer only
 9DE 0333 Delta RP32527
 9GB 0333 Gerber 89-082
 9KO 0333 Kohler 78825
 9MO 0333 Moen 101198 (discontinued)
 9MO 0334 Moen 101708 (female end)
 9PF 0645 Price Pfister 951-045

AUTOMATIC SPRAY DIVERTERS

The one piece diverter, in most cases, will replace the two piece units and are found in many faucets currently manufactured. Additional OEM diverters shown below.

 9/32	 17/32	 11/16	 1-1/8		
802B008 403-1	802B009 403-2	802B010 403-3	802B016 403-7	802B005 405-A	802B006 405-B

AM. KITCHENS 405-1	AMERICAN STD 30757	CHICAGO FCT 1103-006	DELTA RP6073	DELTA RP320	DELTA RP44124 (includes spout O-rings & gasket)
802B004	802B023	802B029	802B024	802B012	802B033

ELKAY A52404	GERBER 98-525	KOHLER 30422	KOHLER 75878	MOEN, OTHERS 406	MOEN 91192 / 1589
802B021	802B028	802B022	802B027	802B013	802B014

CAT NO.	#:	Description:
802B004	405-1	Various manufacturers
802B005	405-A	Various manufacturers <i>discontinued</i>
802B006	405-B	Various manufacturers
802B008	403-1	Briggs, Chicago, Eljer, Kohler, others
802B009	403-2	Burlington, Central, Indiana, UB, others
802B010	403-3	Crane, Kohler, P/Pfister, Reppal, others
802B012	RP320	Delta, Peerless, Gerber
802B013	406	Bal-Cam, Moen, Vance
802B014	1589	Moen
802B016	403-7	Delta(Delex), Nile, Sterling, Valley
802B018	407	Nile, Valley
802B021	A54204	Elkay
802B022	30422	Kohler
802B023	30757	American Standard
802B024	RP6073	Delta
802B025	33	Price Pfister
802B026	951-050	Price Pfister
802B027	75878	Kohler
802B028	98-525	Gerber
802B029	1103-006	Chicago
802B030	974-002	Price Pfister

PRICE PFISTER 951-050	PRICE PFISTER 33
802B026	802B025
PRICE PFISTER 974-002	VALLEY 407
802B030	802B018

DELTA QUICK-SNAP® PULL OUT SPRAY HEAD SYSTEM

If unsure if your faucet is Quick-Snap® and was manufactured BEFORE September 2002, please order: 9DE0335 (RP31612.)

- CAT NO.**
 9DE 0334 RP39345 Hose & head only
 9DE 0335 RP31612 Hose, head, receiver, and adapters
 9DE 0336 RP40301 Snap plug (for removing spray system)

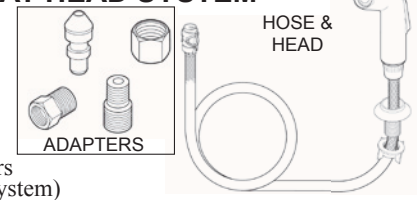

INDIVIDUAL PARTS / FAUCET REPAIRS

AQUA-PURE™ WATER FILTERS

Aqua-Pure APC77 REPLACEMENT WATER FILTER

- The APC77 filter reduces dirt, rust, and sediment as well as chlorine taste & odor.

- Service Life 200 Gallons
- 5 Microns
- Outside Dia 3 1/4 In
- Length 11 1/4 In
- Removes chemical, odors, and taste.
- For Cuno Model APCRF

CAT NO. 937 D 028 **OEM:** APC77



Aqua-Pure APC78 REPLACEMENT WATER FILTER

- The APC78 filter reduces lead, dirt, rust, and sediment as well as chlorine taste & odor.

- 1/2 GPM flow rate
- Service Life 200 Gallons
- 5 Microns
- Outside Dia 3 1/4 In
- Length 11 1/4 In

For Cuno Model APCRF

CAT NO. 937 D 029 **OEM:** APC78



Aqua-Pure AP110 REPLACEMENT WATER FILTER

AP110, 124, and 420 cartridges fit whole house systems AP101T, AP11, AP101, AP102 as well as any other filter housings that meet the same size requirements.

The AP110 is exclusive graded density design allows for up to 30% longer life than most filters in its same class. The AP110 can withstand extreme pressure drops and stress such as water hammer.

Specifications:

- Cartridge size 9 3/4" X 2 5/8"
- 5 Micron Rating
- For fine or normal sediment
- 8 Gallon per minute Flow Rate
- Max Temp: 170 Degrees

The AP110 is a direct replacement for Whirlpool cartridge WHCF-GD05.

CAT NO. 937 D 009 **OEM:** AP110

1-30

Crest/Good Mfg. Co., Manufacturers of Quality Plumbing & Heating Specialties & Brass Since 1896
90 Gordon Drive, Syosset, NY 11791 • East./Central Phone: 1-800-645-1251 • Mtn./Pacific Phone: 1-800-862-7378



Aqua-Pure AP111 REPLACEMENT WATER FILTER

The Aqua-Pure AP111 has been discontinued. Use AP 110 (937D009) or AP124 (937D011) instead.

Aqua-Pure AP117 REPLACEMENT WATER FILTER

Replacement cartridge for the AP51T drinking fountain filtering system. *(For cold water only.)*

Specifications:

- Size 9 3/4" X 2 5/8"
- 5 Micron Rating
- For dirt/rust taste/odor
- 3 Gallon per minute

CAT NO. 937 D 015 **OEM:** AP117 (2 pack)



Aqua-Pure AP124 REPLACEMENT WATER FILTER

Same features as the AP110 (shown above), but for harsher conditions.

Specifications:

- Size 9 3/4" X 2 5/8"
- 50 Micron Rating
- For heavy or course sediment
- 8 Gallon per minute Flow Rate

CAT NO. 937 D 011 **OEM:** AP124 (2 pack)



Aqua-Pure AP217 REPLACEMENT WATER FILTER

Model AP217 filters for AP200 system

- Double action for sediment chlorine taste and odor & scale reduction
- 5 Micron Nominal Rating
- Includes a pre- & post- filter with activated granular carbon
- Manufactured from FDA CFR-21 & R-21 compliant materials

CAT NO. 937 D 016 **OEM:** AP217 (2 pack)



Aqua-Pure AP317 REPLACEMENT WATER FILTER

The Model AP317 Ice maker filter attaches to refrigerator water line for either the AP300 or AP305 Ice Maker System

- Reduces sediment, chlorine taste & odor
- Helps control scale buildup

CAT NO. 937 D 020 **OEM:** AP317



Aqua-Pure AP431 REPLACEMENT SCALE INHIBITION FILTER

Replacement cartridge for the AP430SS System (shown on page 1-30.)

Recommended replacement interval: 4-6 months.

CAT NO. 937 D 014 **OEM:** AP431



Aqua-Pure AP420 REPLACEMENT WATER FILTER

Same features as the AP110 (bottom left), but for normal sediment and scale inhibition

Specifications:

- Size 9 3/4" X 2 5/8"
- 50 Micron Rating
- For heavy or course sediment
- 8 Gallon per minute Flow Rate
- Max Temp: 170 Degrees

CAT NO. 937 D 012 **OEM:** AP420



Aqua-Pure AP517 REPLACEMENT WATER FILTER

Model AP517 filters for AP510 system

- Double action for sediment, chlorine taste and odor and scale reduction
- 5 Micron Nominal Rating
- Includes a pre- & post- filter with activated granular carbon
- High capacity (2,000 gallons /6 months)
- Sanitary quick change design allows for quick changing
- Cold Water Use Only (100°)

CAT NO. 937 D 018 **OEM:** AP517



Aqua-Pure AP617 REPLACEMENT WATER FILTER

The Model AP617 fits the AP600 water filter system

- 5 Micron rating
- Stainless steel housing
- Service/bypass valve
- Cartridge change indicator
- 1" connections
- Flow Rate: 8 gpm
- 1270 grams of granular activated carbon

CAT NO. 937 D 021 **OEM:** AP617



INDIVIDUAL PARTS / FAUCET REPAIRS

AQUA-PURE™ WATER FILTERS (Continued)

Aqua-Pure AP810 REPLACEMENT WATER FILTER

This Aqua-Pure sediment cartridge is made from an exclusive Progressive Porosity process that entangles and entraps larger sediment particles toward the outer diameter and progressively smaller particles toward the cartridge core. This allows even loading for maximum cartridge life. In addition, the unique square-grooved surface provides more sediment-trapping surface area than ever before.



CAT NO. 937 D 026
OEM: AP810

Aqua-Pure AP2150 REPLACEMENT WATER FILTER

Specialty filter for Aqua-Pure AP2100 system.
- Flow Rate: 10 gpm



CAT NO. 937 D 027
OEM: AP2150

Aqua-Pure SS4, SS8, SS12 COMMERCIAL FILTER SYSTEMS

Highly efficient filtration systems for commercial applications. High flow design.



- Corrosion resistant 304 stainless construction
- High flow design allows 32 to 228 gpm
- High temperature capacity
- Removable cartridge holders
- Use AP110, AP111, AP117, APS117, AP124, or AP420 filters
- Contoured flow baffle
- 5 year limited warranty

CAT NO. 937 D 022
OEM: SS4
SIZE: 1-1/2" in/out

CAT NO. 937 D 023
OEM: SS8
SIZE: 2" in/out

CAT NO. 937 D 024
OEM: SS12
SIZE: 2" in/out

AQUA-PURE™ FILTER SYSTEMS

Aqua-Pure AP11T FILTER SYSTEM

The Aqua-Pure AP11T whole house water filter system reduces dirt, rust and sand sediment from your water.

Features a pressure relief button and includes the Aqua-Pure AP110 premium replacement cartridge, installation instructions, Aqua-Grip filter wrench and a 10 year warranty.



The AP11T can use any of the following filter cartridges: AP1001, AP1003, AP110, AP111, AP124, AP117, APS117, and the AP420.

The Aqua-Pure AP11T specs:

- 5 Micron Rating
- 3/4" NPT
- Flow Rate 8 Gallons per minute
- 2,000 Gallons or 3-4 month capacity
- Resists Water Hammer
- Built-In Pressure Relief Button

CAT NO. 937 D 006
OEM: AP11T

Aqua-Pure AP101T FILTER SYS-

The Aqua-Pure AP101T whole house water filter system reduces dirt, rust and sand sediment from your water system.

Includes the Aqua-Pure AP110 premium replacement cartridge, installation instructions, filter wrench, built in shutoff valve and a 10 year warranty.



The AP101T can use any of the following filters cartridges: AP1001, AP1003, AP110, AP111, AP124, AP117, APS117, AP420

- The Aqua-Pure AP101T specs:
- Micron Rating - 5
 - Pipe Size 3/4" NPT
 - Flow Rate 8 Gallons per minute
 - High Capacity: 2,000 Gal or 3-4 months

CAT NO. 937 D 004
OEM: AP101T

Aqua-Pure AP102T FILTER SYSTEM

Similar to the AP101T shown on this page, but uses double length (19.5") Aqua-Pure AP110-2 premium replacement cartridges (SOLD SEPARATELY.)

Includes installation instructions, filter wrench, built in shutoff valve and a 10 year warranty.

The Aqua-Pure AP102T specs:
- Micron Rating - 5
- Pipe Size 3/4" NPT
- Flow Rate 16 gals per minute
- High Capacity 2,000 Gal or 4-5 months

CAT NO. 937 D 005
OEM: AP102T



Aqua-Pure AP200 FILTER SYSTEM

The AP200 features a compact, yet full flow design. Includes high capacity sediment cartridge with carbon media



Ideal for use in areas with space limitations such as under bathroom sinks. Attach directly to existing faucet. Higher sediment holding than our standard cartridges Reduces chlorine taste and odor.

- Specifications:
- 5 Micron rating
 - 2 Gallons per minute
 - 3/8" NPT pipe fittings
 - 2000 Gallon filter capacity
 - 10 Year Limited System Warranty

NOT FOR SALE IN CALIFORNIA.

CAT NO. 937 D 017
OEM: AP200

notes:



INDIVIDUAL PARTS / FAUCET REPAIRS

AQUA-PURE™ WATER FILTERS

1 Aqua-Pure AP430SS SCALE INHIBITION FILTER SYSTEM

The AP430SS system helps bind calcium and magnesium hardness minerals, helping to prevent them from precipitating out of solution and building up on metallic surfaces.

Prevents corrosion in piping systems, inhibits scale build up in water heaters and appliances, and helps extend the life of hot water systems.

Stainless steel fitting stands up to harsh environments

Specifications:

- Contains Siliphos, USDA approved food grade scale inhibitor
- Stainless Steel Head
- 6 Gallons per minute flow rate
- Max operating Temp 100°F

CAT NO. 937 D 013 OEM: AP430SS



Aqua-Pure AP1610SS FILTER SYSTEM

The Aqua-Pure AP1610SS whole house water filter system reduces dirt, rust and sand sediment from your water.

Includes the AP1610SS 304 Stainless Steel Housing, Aqua-Pure AP110 premium replacement cartridge, installation instructions, filter wrench, and a 10 year warranty.

- Rated to 300 psi
- 3/4" IPS inlet/outlet
- Flow Rate 8 Gallons per minute
- Hot or Cold water (must use AP2005 cartridge for hot water)
- Includes AP110 Cartridge

CAT NO. 937 D 007 OEM: AP1610SS



Notes:

5 Aqua-Pure AP717 ICE MAKER FILTER SYSTEM

Model AP717 is a stand alone filter that attaches to your refrigerator water line

- Triple Action Filtration
- 5 Micron rating
- Reduces sediment, chlorine taste & odor
- Helps control scale buildup
- Easy cartridge change-out

CAT NO. 937 D 019 OEM: AP717



Aqua-Pure AP2610SS FILTER SYSTEM

Similar to the AP1610SS shown above, but uses TWO Aqua-Pure AP110 cartridges

Includes the AP2610SS 304 Stainless Steel Housing, two Aqua-Pure AP110 premium replacement cartridges, installation instructions, filter wrench, and a 10 year warranty.

- Rated to 300 psi
- 3/4" IPS inlet/outlet
- Flow Rate 16 gpm
- Hot or Cold water (must use AP 2005 cartridges for hot water)
- Includes AP110 Cartridge

CAT NO. 937 D 008 OEM: AP2610SS



8 Aqua-Pure AP801 WATER FILTER SYSTEM

The Model AP801 system is for 2-3 bathroom homes, and addresses sediment, taste, and odor concerns.

- Cold water application only
- Available in 1" and 1.5" connections
- Flow Rates Up to 60 gpm
- Uses AP810 carbon cartridges (below)

CAT NO. 937 D 025 OEM: AP801 (specify connection size)



INDIVIDUAL PARTS / FAUCET REPAIRS

FAUCET SWING SPOUTS

MEASURE SPOUTS LIKE THIS:

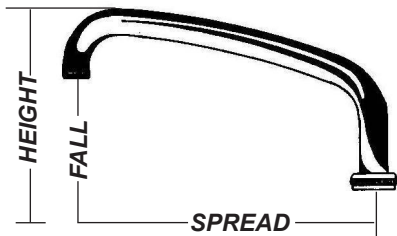

TYPE: **HYDROMOLD:** Solid casting, usually made of chrome plated pot metal or zinc.
CAST: Solid casting, usually made of chrome plated brass.
TUBULAR: Thin walled chrome plated tubular brass.

INLET: Usually the inlet nut's diameter.

SPREAD: The distance between the center of the spout's outlet (aerator) and the center of the inlet or inlet nut. (Measured PARALLEL to the floor.)

FALL: The distance between the bottom of the aerator and the bottom of the spout.

HEIGHT: The distance between the top of the spout and the bottom of the spout.

AMERICAN KITCHENS

CAT #: 949 I 016
 INLET: 1-7/16
 TYPE: Hydromold
 SPREAD: 8"

USED ON:
 Wall Mount LF110, LF210, others

AMERICAN STANDARD

CAT #: 949 I 019
 INLET: 2-3/8"
 TYPE: Cast
 SPREAD: 8-5/8"

USED ON:
 Aquarian, 4179-016, others

BRIGGS

CAT #: 949 I 026
 INLET: 1-3/8"
 TYPE: Hydromold
 SPREAD: 8"

USED ON:
 T9200, 01, 05, 06, 07, 08, others

AMERICAN KITCHENS

CAT #: 949 I 027
 INLET: 1-3/8"
 TYPE: Hydromold
 SPREAD: 8"

USED ON:
 Wall Mount LF100, LF200, others

AMERICAN STANDARD

CAT #: 949 I 022
 INLET: 1-1/2"
 TYPE: Hydromold
 SPREAD: 7-7/8"

USED ON:
 4150, 4152, N4001, N4033, others

CENTRAL BRASS

CAT #: 949 I 005
 INLET: 1-3/16"
 TYPE: Tubular
 SPREAD: 8"

USED ON:
 120, 121, 125, 146, 147, others

CENTRAL BRASS

CAT #: 949 I 004

INLET: 1-3/16"
 TYPE: Tubular
 SPREAD: 12"

USED ON:
 Deck, Bar faucets

CHICAGO

CAT #: 9CF0312 (Chrome)
 CAT #: 9CF0311 (Rough)
 OEM: 305-S VB

SPREAD: 2-3/8"
 HEIGHT: 3-1/8"
 FALL: 1/2"

OUTLET: GARDEN HOSE
 (RIGID ONLY)

POLISHED (CP) OR
 ROUGH CHROME (RCF)

CHICAGO

CAT #: 9CF1062 (Chrome)
 OEM: DB6A

SPREAD: 6-1/4"
 HEIGHT: 6-3/8"
 FALL: 3-1/8"

OUTLET: TYPE "A" (LESS AERATOR)
 (RIGID/SWING)

CHICAGO

CAT #: 9CF0623 (7")
 OEM: 686-124

CAT #: 9CF0625 (11-3/4")
 OEM: 686-126
 (SWING ONLY)

USE WITH ANY OTHER CHICAGO SPOUT TO
 CREATE A CUSTOM DOUBLE JOINT SPOUT,
 OR ADD TO A DOUBLE JOINT SPOUT TO
 CREATE A TRIPLE JOINT SPOUT.

CHICAGO

CAT #: 9CF1061
 OEM: DJ 13

SPREAD: 13"
 HEIGHT: 2-1/4"
 FALL: 3-7/8"

OUTLET: TYPE "A" (WITH E3 AERATOR)
 (SWING ONLY)

CHICAGO

CAT #: 9CF0975
 OEM: DJ 18









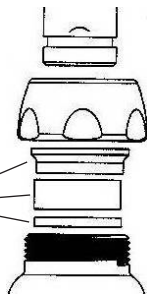

SPREAD: 18"
 HEIGHT: 2-1/4"
 FALL: 3-7/8"

OUTLET: TYPE "A" (WITH E3 AERATOR)
 (SWING ONLY)

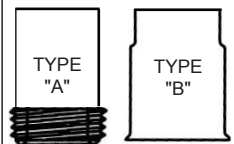

INDIVIDUAL PARTS / FAUCET REPAIRS

FAUCET SWING SPOUTS (cont.)

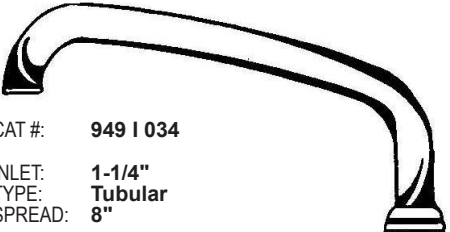
<p>CHICAGO</p>  <p>CAT #: 9CF1055 OEM: GN1A</p> <p>SPREAD: 3-1/2" HEIGHT: 8-3/8" FALL: 5-7/8"</p> <p>OUTLET: TYPE "A" (LESS AERATOR) (RIGID/SWING)</p>	<p>CHICAGO SPOUT REPAIR KITS</p> <p>CF51: To convert rigid spouts to swivel, and vice versa.</p>  <p>CF52: To repair a leaky spout. <i>(includes 3 pieces shown)</i></p>	<p>CHICAGO</p> <p>Available in flow control version</p>  <p>CAT #: 9CF1058 OEM: GN2A</p> <p>CAT #: 9CF1060 OEM: GN2A-FC (Flow control version)</p> <p>SPREAD: 5-1/4" HEIGHT: 9-3/4" FALL: 6-1/8"</p> <p>OUTLET: TYPE "A" (LESS AERATOR)</p>
<p>CHICAGO</p>  <p>CAT #: 9CF1059 OEM: GN2B</p> <p>SPREAD: 5-3/8" HEIGHT: 9-3/4" FALL: 5-3/8"</p> <p>OUTLET: TYPE "B" (LESS AERATOR) (RIGID/SWING)</p>	<p>CHICAGO</p> <p>Available in flow control version</p>  <p>CAT #: 9CF1054 OEM: GN2</p> <p>CAT #: 9CF1056 OEM: GN2-FC (Flow control version)</p> <p>SPREAD: 5-1/4" HEIGHT: 9-3/4" FALL: 6-1/8"</p> <p>OUTLET: NONE (PLAIN END SPOUT)</p>	<p>CHICAGO</p>  <p>CAT #: 9CF1092 OEM: GN2B VB</p> <p>SPREAD: 6" HEIGHT: 9-1/2" FALL: 5-3/4"</p> <p>OUTLET: TYPE "B" (LESS AERATOR) (RIGID/SWING)</p>
<p>CHICAGO</p>  <p>CAT #: 9CF1057 OEM: GN8A</p> <p>SPREAD: 8" HEIGHT: 11-1/4" FALL: 6"</p> <p>OUTLET: TYPE "A" (LESS AERATOR) (RIGID/SWING)</p>	<p>CHICAGO</p>  <p>CAT #: 9CF1044 OEM: L12</p> <p>SPREAD: 12" HEIGHT: 4-5/8" FALL: 2-3/8"</p> <p>OUTLET: TYPE "A" (WITH E3 AERATOR) (SWING ONLY)</p>	<p>CHICAGO</p>  <p>CAT #: 9CF1045 OEM: L15</p> <p>SPREAD: 14" HEIGHT: 4-5/8" FALL: 2-3/8"</p> <p>OUTLET: TYPE "A" (WITH E3 AERATOR) (SWING ONLY)</p>
<p>CHICAGO</p>  <p>CAT #: 949 030 OEM: L8</p> <p>SPREAD: 8" HEIGHT: 4-3/4" FALL: 3"</p> <p>OUTLET: TYPE "A" (WITH E3 AERATOR) (SWING ONLY)</p>	<p>CHICAGO FAUCET SPOUT OUTLETS</p> <p>Chicago faucets use a specialty thread on their male (type "A") spouts. Only Chicago brand aerators and moderators will fit this thread. Female (type "B") spouts have 3/8 FIP thread. See the chart at right:</p>  <p>NOTE: FAUCETS WITH SOLID BRASS SPOUTS, LIKE THE 333, 404, AND 802 SERIES, USE A 13/16 MALE AERATOR, OUR #811C003</p> <p>THE CHICAGO SPOUTS SHOWN ON PAGES 1-31 and 1-32 ARE INTERCHANGEABLE.</p> <p>CHICAGO AERATORS ARE SHOWN ON PAGE 1-26</p>	
<p>CHICAGO</p>  <p>CAT #: 9CF1043 OEM: L9</p> <p>SPREAD: 9-1/2" HEIGHT: 6-1/2" FALL: 3-5/8"</p> <p>OUTLET: TYPE "A" (WITH E3 AERATOR) (SWING ONLY)</p>	<p>CHICAGO</p>  <p>CAT #: 9CF1040 OEM: S6</p> <p>SPREAD: 6" HEIGHT: 1-3/4" FALL: 1/8"</p> <p>OUTLET: TYPE "A" (WITH E3 AERATOR) (SWING ONLY)</p>	<p>CRANE (REPCAL)</p>  <p>CAT #: 949 034</p> <p>INLET: 1-1/4" TYPE: Tubular SPREAD: 8"</p> <p>USED ON: Deck faucets 8511, 8514</p>



INDIVIDUAL PARTS / FAUCET REPAIRS

FAUCET SWING SPOUTS (cont.)

CRANE (REPCAL)

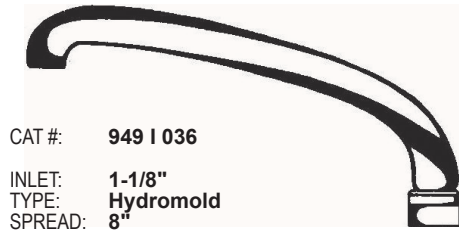

CAT #: 949 I 036
 INLET: 1-1/8"
 TYPE: Hydromold
 SPREAD: 8"

USED ON:
 Deck faucets 8-2720, 8-2724, others

CRANE (REPCAL)

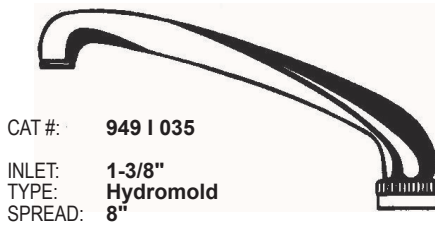

CAT #: 949 I 035
 INLET: 1-3/8"
 TYPE: Hydromold
 SPREAD: 8"

USED ON:
 Slant back - Capri 8-2710-A

CRANE (REPCAL)

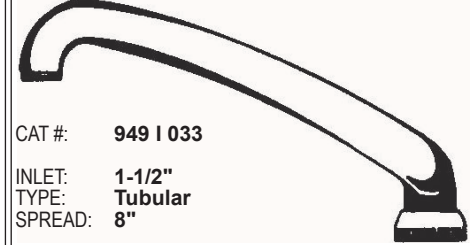

CAT #: 949 I 033
 INLET: 1-1/2"
 TYPE: Tubular
 SPREAD: 8"

USED ON:
 Deck faucets 8-4700, 8-4702

DELTA



CAT #: 949 I 301
 OEM #: RP5881

INLET: 1-23/32"
 TYPE: Cast
 SPREAD: 4"

USED ON:
 Single handle lav faucets

**AERATORS FOR
 ALL SPOUTS ARE
 SHOWN ON
 PAGE 1-26.**

DELTA



CAT #: 949 I 302
 OEM #: RP9633

INLET: 1-23/32"
 TYPE: Cast
 SPREAD: 6"

USED ON:
 Single handle kitchen faucets

DELTA



CAT #: 949 I 037
 OEM #: RP5654

INLET: 1-23/32"
 TYPE: Cast
 SPREAD: 8"

USED ON:
 Single handle kitchen faucets

DELTA

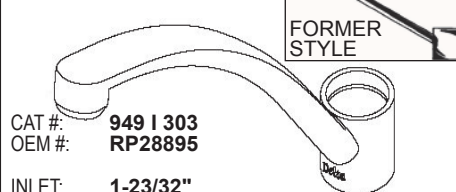

CAT #: 949 I 303
 OEM #: RP28895

INLET: 1-23/32"
 TYPE: Cast
 SPREAD: 9"

USED ON:
 Single handle kitchen faucets

DELTA

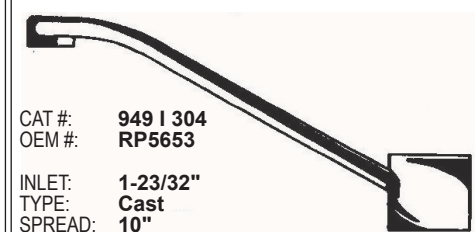

CAT #: 949 I 304
 OEM #: RP5653

INLET: 1-23/32"
 TYPE: Cast
 SPREAD: 10"

USED ON:
 Single handle kitchen faucets

DELTA

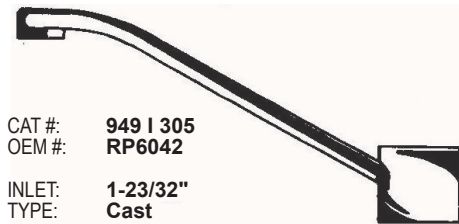

CAT #: 949 I 305
 OEM #: RP6042

INLET: 1-23/32"
 TYPE: Cast
 SPREAD: 12"

USED ON:
 Single handle kitchen faucets

DELTA (DELEX)

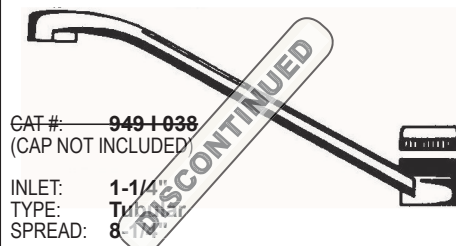

CAT #: 949 I 038
 (CAP NOT INCLUDED)

INLET: 1-1/4"
 TYPE: Tubular
 SPREAD: 8"

USED ON:
 2 handed kitchen faucets

DICK BROTHERS

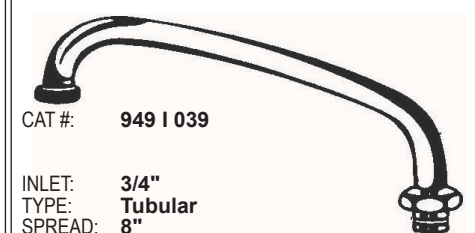

CAT #: 949 I 039

INLET: 3/4"
 TYPE: Tubular
 SPREAD: 8"

USED ON:
 Single handle kitchen faucets

FISHER

Swing spouts

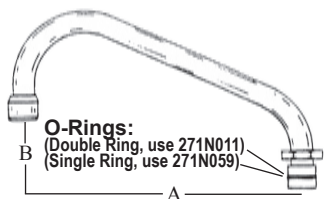

O-Rings:
 (Double Ring, use 271N011)
 (Single Ring, use 271N059)

CAT NO.	A	B	OEM (old vs new)
937F032	6	2"	3960 /
937F050	8	2-1/2"	3961 /
937F033	10	3"	3962 /
937F034	12	3-3/4"	3963 /
937F035	14	4-1/4"	3964 /

FISHER

Double jointed
 swing spouts

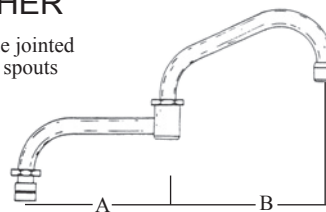

CAT NO.	A	B	Total	OEM
937F038	7"	6"	13"	3970
937F039	7"	8"	15"	3971
937F040	9"	8"	17"	3972
937F041	9"	10"	19"	3973

FISHER

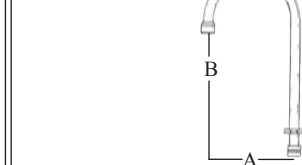





CAT NO.	STYLE	A	B	OEM
937F042	Swing	3-1/2"	6"	3968
937F036	Swing	6"	6-1/4"	3965
937F043	Rigid	3-1/2"	6"	3969
937F037	Rigid	5-1/2"	6"	3966

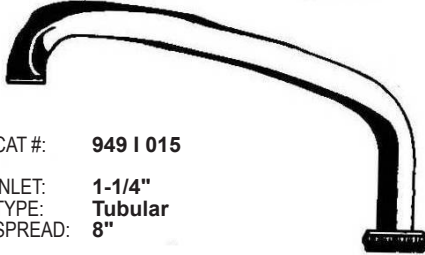
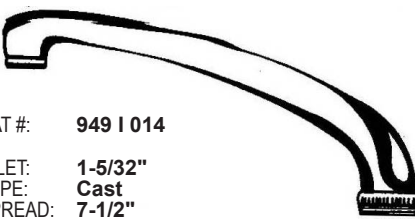

INDIVIDUAL PARTS / FAUCET REPAIRS

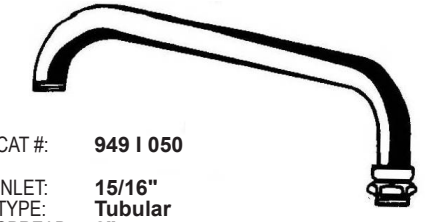
FAUCET SWING SPOUTS (cont.)

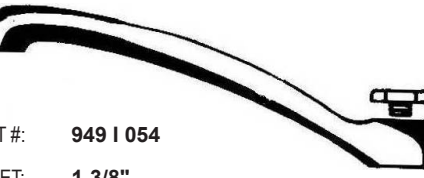
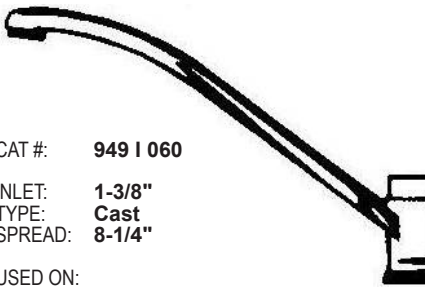
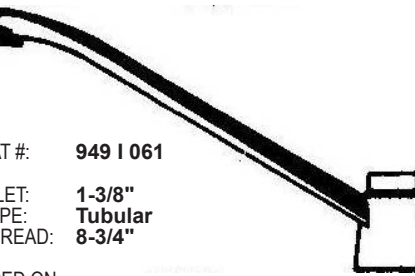
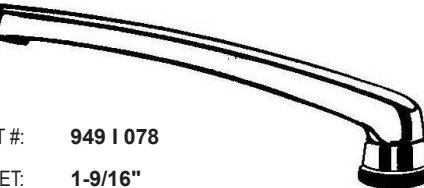
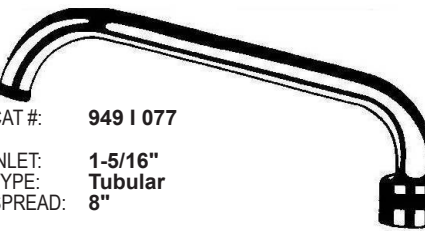
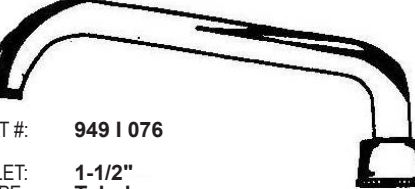
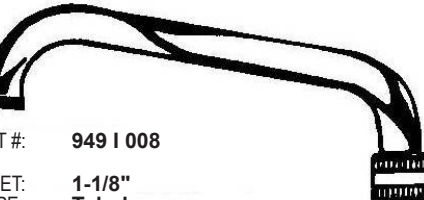
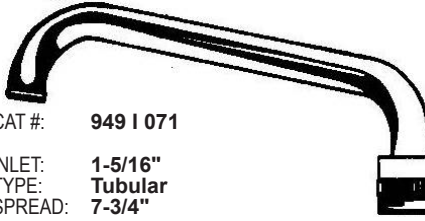
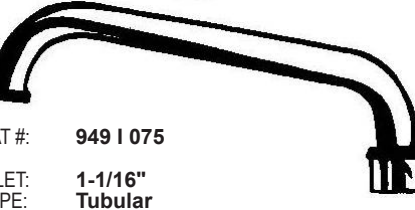
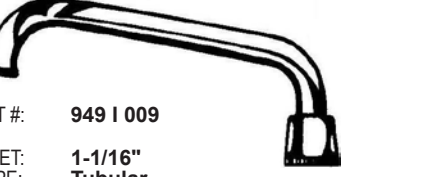
<p>1 2</p> <p>GERBER</p>  <p>CAT #: 9491015 INLET: 1-1/4" TYPE: Tubular SPREAD: 8"</p> <p>USED ON: Deck faucets 42-250, 42-360, 42-380, others</p>	<p>GERBER</p>  <p>CAT #: 9491014 INLET: 1-5/32" TYPE: Cast SPREAD: 7-1/2"</p> <p>USED ON: Deck faucets 42-260, 42-270</p>	<p>GERBER</p>  <p>CAT #: 9491042 INLET: 1-1/4" TYPE: Cast SPREAD: 7-1/2"</p> <p>USED ON: Deck faucets 42-250, 42-260, 42-270, others</p>
<p>3 4</p> <p>KOHLER</p>  <p>CAT #: 9491050 INLET: 15/16" TYPE: Tubular SPREAD: 8"</p> <p>USED ON: Deck K10400, 10405, 10420, others</p>	<p>KOHLER</p>  <p>CAT #: 9491051 INLET: 1-3/8" TYPE: Cast SPREAD: 8"</p> <p>USED ON: Deck K10900, 10905, 11900, others</p>	<p>KOHLER</p>  <p>CAT #: 9491054 INLET: 1-3/8" TYPE: Cast SPREAD: 8"</p> <p>USED ON: Deck K7761, 63, 65, k7821, others</p>
<p>5 6</p> <p>MOEN</p>  <p>CAT #: 9491060 INLET: 1-3/8" TYPE: Cast SPREAD: 8-1/4"</p> <p>USED ON: Single lever kitchen 7500-26 series</p>	<p>MOEN</p>  <p>CAT #: 9491061 INLET: 1-3/8" TYPE: Tubular SPREAD: 8-3/4"</p> <p>USED ON: Single lever kitchen 722-9A series</p>	<p>PRICE PFISTER</p>  <p>CAT #: 9491078 INLET: 1-9/16" TYPE: Cast SPREAD: 8"</p> <p>USED ON: Flowmatic kitchen series</p>
<p>7</p> <p>PRICE PFISTER</p>  <p>CAT #: 9491077 INLET: 1-5/16" TYPE: Tubular SPREAD: 8"</p> <p>USED ON: Contessa kitchen faucets</p>	<p>PRICE PFISTER</p>  <p>CAT #: 9491076 INLET: 1-1/2" TYPE: Tubular SPREAD: 7-3/4"</p> <p>USED ON: Deck 35-011, 35-021, 35-111, 35-121</p>	<p>PRICE PFISTER</p>  <p>CAT #: 9491008 INLET: 1-1/8" TYPE: Tubular SPREAD: 8"</p> <p>USED ON: Deck 711, 714, 750, 37-010, 37-120</p>
<p>8 9</p> <p>PRICE PFISTER</p>  <p>CAT #: 9491071 INLET: 1-5/16" TYPE: Tubular SPREAD: 7-3/4"</p> <p>USED ON: Deck 703A, 703R, 704R, 704A</p>	<p>PRICE PFISTER</p>  <p>CAT #: 9491075 INLET: 1-1/16" TYPE: Tubular SPREAD: 7-3/4"</p> <p>USED ON: Deck 590A, 590R, 31-110 thru 31-120</p>	<p>PRICE PFISTER</p>  <p>CAT #: 9491009 INLET: 1-1/16" TYPE: Tubular SPREAD: 8"</p> <p>USED ON: Deck 711S, 716S, 750, 754, 780, others</p>



INDIVIDUAL PARTS / FAUCET REPAIRS

FAUCET SWING SPOUTS (cont.)

PRICE PFISTER



CAT #: 949 I 072

INLET: 1-9/32"
TYPE: Tubular
SPREAD: 8"

USED ON:
Deck faucets 758, 762, 788, 792, 1030A

SAVOY

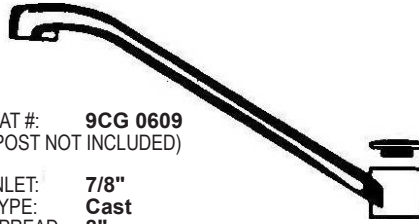

CAT #: 9CG 0609
(POST NOT INCLUDED)

INLET: 7/8"
TYPE: Cast
SPREAD: 8"

USED ON:
Deck faucets KF1710, LF 1711, KF1712, 13, 14

STERLING

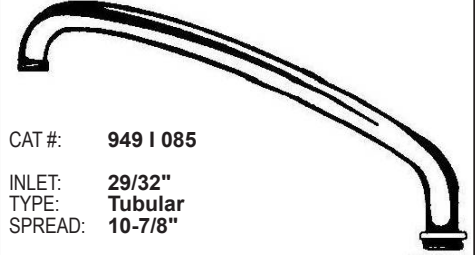

CAT #: 949 I 085

INLET: 29/32"
TYPE: Tubular
SPREAD: 10-7/8"

USED ON:
Wall mounted bar faucets

STERLING

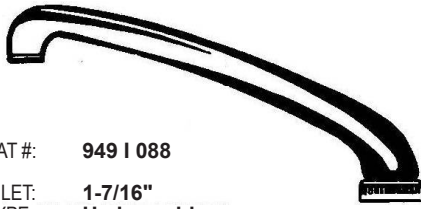

CAT #: 949 I 088

INLET: 1-7/16"
TYPE: Hydromold
SPREAD: 8"

USED ON:
Deck faucets 264-190, 268-510, 2612-10

STERLING

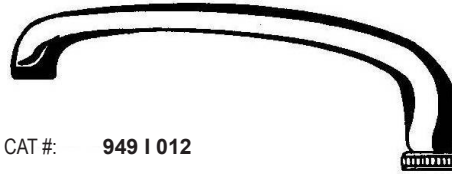

CAT #: 949 I 012

INLET: 1-1/8"
TYPE: Hydromold
SPREAD: 8"

USED ON:
256-10-30-50-70, 257-10-30-50-70, others

STERLING

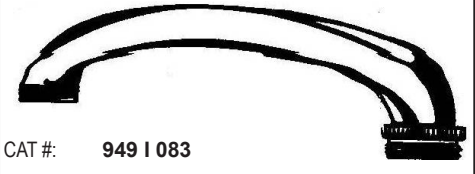

CAT #: 949 I 083

INLET: 15/16"
TYPE: Hydromold
SPREAD: 6"

USED ON:
Wall mounted faucets 27-010, 27-750, 273, 275

T&S BRASS

Swing spouts with soap dish

CAT #: TS160X 6"
TS161X 8"
TS162X 12"
TS163X 18"

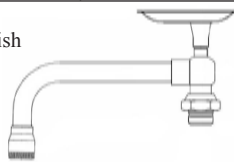

INLET: T&S Brass swivel only

T&S BRASS

Gooseneck spouts

CAT #:	SPREAD:	FALL:	HEIGHT:	OEM:
TS119X	2-3/4"	4-1/2"	8"	119X(R)
TS120X	5-1/2"	4-1/2"	10-1/4"	120X(R)
TS123X	5-1/2"	7-1/2"	12-1/2"	123X(R)
TS129X	8-1/2"	4-1/2"	11-3/4"	129X(R)

TS131X	2-3/4"	2-1/2"	4-3/4"	133X(S)
TS133X	6-3/8"	4-1/2"	10-3/8"	133X(S)
TS135X	8-3/4"	5-1/8"	12-1/16"	135X(S)

KEY:
(R) = rigid (S) = swing

AS ABOVE, BUT WITH
MOUNTING BASE (1/2")
FOR COUNTER TOP:

9TS0430 (oem B-0430)
Empty mounting assy only.

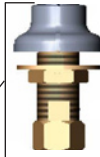

CAT #:	SPREAD:	FALL:	HEIGHT:	OEM:
9TS0399	5-1/2"	5-1/8"	10-1/4"	B520 (R)
9TS0400	5-1/2"	4-1/2"	10-1/4"	B521 (R)
<i>(9TS0400 is same as 9TS0399, but adds aerator.)</i>				
9TS0401	5-1/2"	4-1/2"	10-1/4"	B522 (R)
<i>(9TS0401 is same as 9TS0399, but adds rose spray.)</i>				
9TS0402	5-1/2"	6-3/4"	12-1/4"	B523 (R)
9TS0403	8-3/4"	5-1/8"	12-1/16"	B524 (R)
<i>(9TS0403 is same as 9TS0402, but adds rose spray.)</i>				

KEY:
(R) = rigid

T&S BRASS

Swing spouts

CAT #:	SPREAD:	FALL:
TS59X	6"	2"
TS60X	8"	2-1/4"
TS61X	10"	3"
TS62X	12"	3-3/4"
TS63X	14"	4-1/8"
TS65X	18"	5-3/4"

INLET: T&S Brass swivel only

USED ON:
Pre-rinse units and commercial faucets

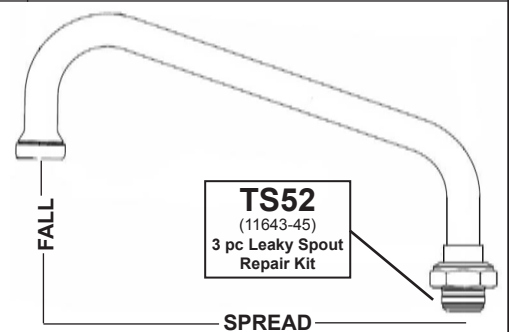

TS52
(11643-45)
3 pc Leaky Spout
Repair Kit

T&S BRASS

Double jointed swing spouts

CAT #:	A:	B:	FALL:	HEIGHT:
TS66X	6"	6"	4-1/4"	8-1/4"
TS67X	9"	6"	4-1/4"	8-1/4"
TS68X	12"	6"	4-1/4"	8-1/4"
TS69X	12"	12"	4-1/4"	8-1/4"
TS116X	12"	12"	<i>(FOR BIG FLO FAUCETS ONLY)</i>	

USED ON:
Pre-rinse units and commercial faucets

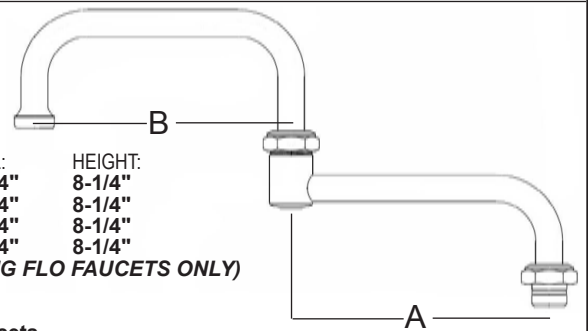

T&S BRASS

spouts for Big-Flo faucets

CAT #:	SPREAD:	FALL:	HEIGHT:
TS114X	12"	5-1/2"	8-1/2"
TS115X	18"	7-1/2"	10-1/2"

USED ON:
Big-Flo (pot filler) faucets ONLY

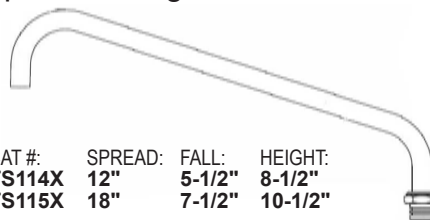

YOUNGSTOWN

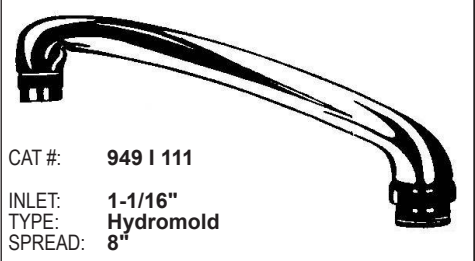

CAT #: 949 I 111

INLET: 1-1/16"
TYPE: Hydromold
SPREAD: 8"

USED ON:
Kitchen faucets 60954-55-56-57



INDIVIDUAL PARTS / FAUCET REPAIRS

REPLACEMENT HANDLES AND ADAPTERS

1 CREST/GOOD FIT-ALL HANDLE ASSORTMENT

24 HANDLES,
75+ ADAPTERS,
AND MORE!



CAT NO. 261C990 DESCRIPTION Fit All Handle Assortment

Crest/Good's fit-all replacement handle assortment offers a quick and easy system for replacing faucet and shower handles. Save time and money over stocking OEM handles by reducing over 80 OEM handle choices with these 6 different sized handles.

Use this kit for basins, sinks, and tubs for a perfect fit every time. Kit includes 16 handles, 60 adapters, 60 handle screws (with Jiffy Tap,) broach selector, and instruction chart, packed in a heavy duty metal suitcase.



CAT NO. 591 I 095 Broach selector

3 INDIVIDUAL FIT-ALL METAL REPLACEMENT HANDLES

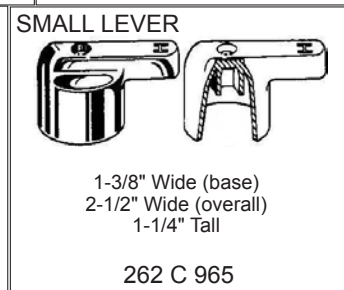
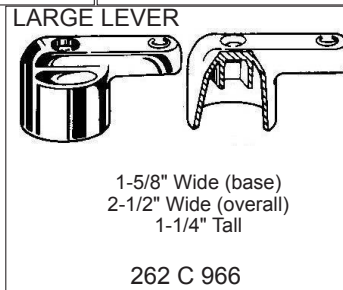
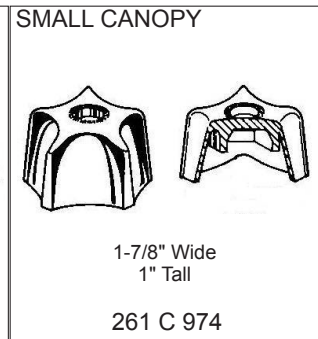
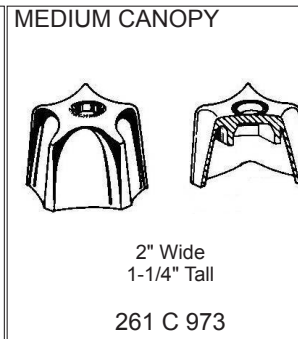
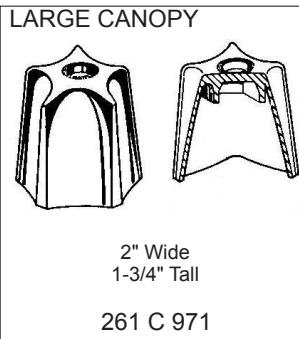
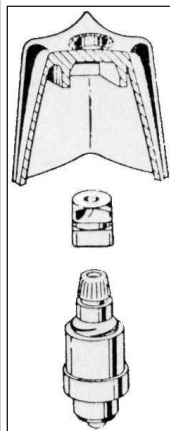

CAT NO. DESCRIPTION
261 C 971 Large Canopy Fit All Handles (PAIR)
261 C 972 Medium Large Canopy Fit All Handles (PAIR)
261 C 973 Medium Canopy Fit All Handles (PAIR)
261 C 974 Small Canopy Fit All Handles (PAIR)
262 C 966 Large Lever Fit All Handles (PAIR)
262 C 965 Small Lever Fit All Handles (PAIR)

7 INDIVIDUAL FIT-ALL DECO REPLACEMENT HANDLES

Replace cross or canopy shower handles with these new cross handles. Our exclusive design features a solid brass insert to match many brands. Sold as a pair, or as a single diverter handle.

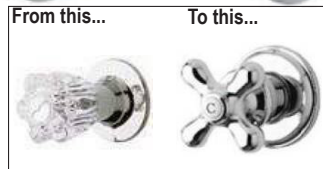

H & C CAT NO:	DIVERTER CAT NO:	MFR:
VP601	VP651	American Std
VP602	VP652	Briggs
VP603	VP653	Central Brass
VP604	VP654	Chicago
VP605	VP655	Gerber
VP606	VP656	Kohler
VP607	VP657	Price Pfister
VP608	VP658	Repcal
VP609	VP659	Savoy
VP610	VP660	Sayco

Every kit includes either hot & cold, or diverter handle, plus: matching brass broach inserts, screws, & porcelain buttons.

INDIVIDUAL FIT-ALL LUCITE CLEAR REPLACEMENT HANDLES

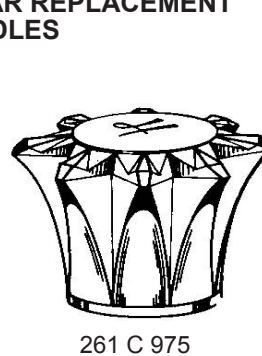

CAT NO. DESCRIPTION
261 C 975 SMALL Lucite Fit All Handles (H & C)
261 C 978 SMALL Lucite Fit All Handles (Diverter)
261 C 981 LARGE Lucite Fit All Handles (H & C)
261 C 984 LARGE Lucite Fit All Handles (Diverter)



INDIVIDUAL PARTS / FAUCET REPAIRS

REPLACEMENT HANDLES AND ADAPTERS

FIT-ALL REPLACEMENT HANDLES WITH VISE-GRIP LOCK

These handles feature an exclusive "VISE-GRIP-LOCK" system that holds tightly to badly worn broaches. Tightening screws on each side of the attached adapter locks the handle onto the stem.



VP 100



VP 200



VP 400

CAT NO.	DESCRIPTION
VP100	Cross Handles (H & C)
VP200	Lever Handles (H & C)
VP400	Lucite Handles (H & C)

FIT-ALL WRIST BLADE HANDLES

These handles come complete with adapters shown below.

A less expensive alternative to OEM wrist handles.

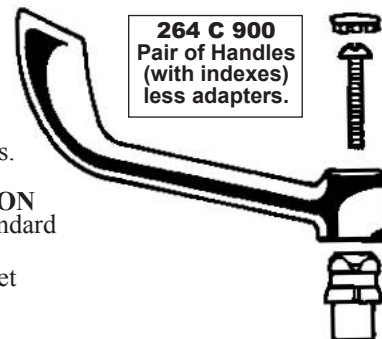

264 C 900
Pair of Handles
(with indexes)
less adapters.

CAT NO.	DESCRIPTION
AS90HX	American Standard
CB90HX	Central Brass
CF90HX	Chicago Faucet
CR90HX	Crane
EJ90HX	Eljer
KO90HX	Kohler
SC90HX	Sayco
SP90HX	Speakman
TS90HX	T&S Brass

Each kit includes hot & cold wrist blade handles, matching brass broach inserts, screws, and chrome index buttons.

HANDLE SCREWS AND ADAPTERS

CHROME PLATED BRASS HANDLE SCREWS

Save money with our exclusive 10-24 handle screws & Jiffy Tap tool... One thread size to fit all faucet handles. Our handle screw assortment includes tap tool plus screw chart and manufacturers' listing of charts.



ROUND HEAD



TRUSS HEAD



OVAL HEAD



FILLISTER HEAD

CAT NO.	#	HEAD:	SIZE:	
226 C 002	107	Round	8-32	x 1/2"
947 B 300		Round	8-32	x 3/4"
227 C 067		Round	8-32	x 1"
227 C 001*	110	Round	10-24	x 3/8"
227 C 002*	111	Round	10-24	x 1/2"
227 C 066		Round	10-24	x 1"
941 B 003		Round	10-24	x 1-3/4" (plain brass)
861 A 010		Round	10-32	x 3/4" (plain brass)
227 C 068		Round	10-32	x 1"
947 S 021		Truss	4-40	x 1/2"
227 C 003	112	Truss	10-24	x 3/8"
227 C 016		Truss	10-24	x 1/2"
227 C 006*	115	Lg. Oval	10-24	x 3/8"
227 C 007*	116	Lg. Oval	10-24	x 1/2"
227 C 008	120	Lg. Oval	10-32	x 1/2"
227 C 017*	1970	Lg. Oval	10-24	x 3/4"
947 S 687		Oval	6-32	x 3/8"
227 C 015		Oval	8-32	x 1/2"
227 C 028		Oval	8-32	x 3/4"
227 C 030		Oval	8-32	x 1-3/4"
227 C 024*	117	Oval	10-24	x 5/8"
227 C 026*	119	Oval	10-24	x 1-1/2"
227 C 029		Oval	10-24	x 2-1/2" (PAIR)
960 A 310		Oval	10-28	x 1/2"
227 C 027	122	Oval	10-32	x 3/4"
227 C 009	103	Fillister	8-32	x 5/16" (plain brass)

*(included in kit shown below.)

9AS6611 28611 Set of 3 specialty screws for Am Std



HANDLE SCREW ASSORTMENT

103 piece assortment

(Includes starred sizes listed above, plus tap tool)

CAT NO.	#
227 C 090	70



INDIVIDUAL ADAPTERS FOR FIT ALL HANDLES

Insert these adapters into any handle on this page to change the look of your faucet or shower.

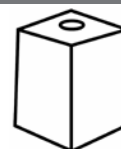

CRESTOLAC

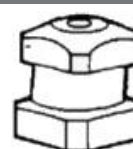

BRASS

CRESTOLAC ADAPTER CAT NO:	BRASS ADAPTER CAT NO:	#:	MFR:	BROACH:
260 P 101	261 C 900	1-1	Crane	12 pt
260 P 102	261 C 901	1-2	Price Pfister	12 pt
	261 C 902	1-4	Am Std, Sterling	22 pt
	261 C 903	1-5	Am Std, Sterling	16 pt
	261 C 904	1-6	Central, Eljer, Savoy	16 pt
260 P 105	261 C 905	1-7	Kohler	19 pt
260 P 106	261 C 906	1-8	Am Std	20 pt
	261 C 907	1-12	Harcraft	12 pt
	261 C 921	1-13	Savoy, Wolverine	15 pt
	261 C 908	2-1	Am Std (Aquaseal)	22 pt
260 P 110	261 C 909	2-2	Youngstown	16 pt
	261 C 910	2-3	Gerber, Sayco	16 pt
	261 C 911	2-4	Speakman	20 pt
260 P 113	261 C 912	2-5	Price Pfister	12 pt
	261 C 913	2-6	Am Std (Colony)	16 pt
260 P 115	261 C 914	3-1	Repcal	12 pt
260 P 116	261 C 915	3-2	Sayco	16 pt
	261 C 916	3-3	Indiana, Union Br	18 pt
	261 C 917	3-4	Barnes, Central	16 pt
	261 C 918	3-7	Am Brs, Empire, Strmwy	17 pt
260 P 120	261 C 919	3-9	Harcraft	12 pt
260 P 121	261 C 920	3-10	Sears, Universal	12 pt
	261 C 926	3-11	Crane Repcal	16 pt
	261 C 924	3-12	Chicago (square)	---
	261 C 922	4-1	Fit All (Screw-on)	---
	261 C 925	4-2	Fit All (with hex screws)	---
	261 C 923	5-1	Am Std Hospital	22 pt



"1" series adapters are 7/16" tall



"2" series adapters are 9/16" tall

















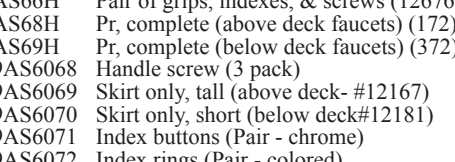
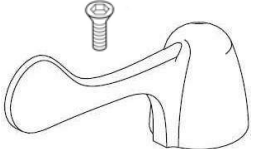
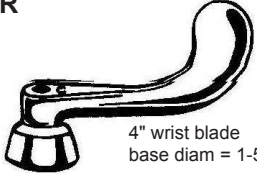

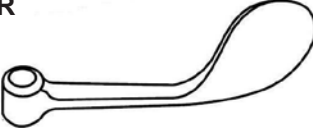
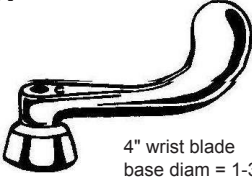
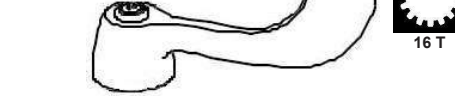
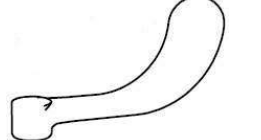

"3" series adapters are 5/8" tall

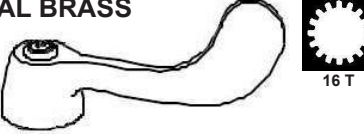

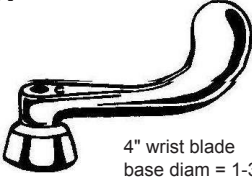
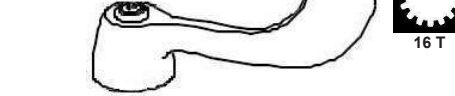
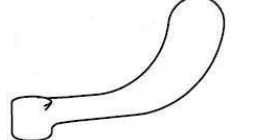
INDIVIDUAL PARTS / FAUCET REPAIRS

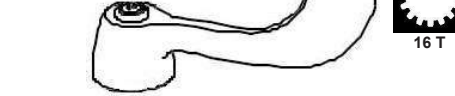
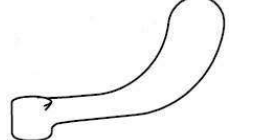
OEM WRIST BLADE HANDLES

<p>1 AMERICAN STANDARD</p>  <p>(4" LONG) (6" LONG)</p> <p>CAT NO. DESCRIPTION AS 10H 4" Pair, with indexes & screws AS381-6 6" Hot only, w/ index & screw AS382-6 6" Cold only, w/ index & screw 121C075 Index buttons (Pair - chrome) 9AS1038 Index buttons (Pair - colored) 227C002 Handle Screw (each)</p>	<p>CRANE</p>  <p>CAT NO. DESCRIPTION CR12H 4" pair, with index nut CR16019 4" hot handle, w/ index nut CR16020 4" cold handle, w/ index nut CR16015 4" handle only, LESS index nut (12857) 9CR1552 6" handle only, LESS index nut (13749) 121C061 Hot index nut only 121C060 Cold index nut only</p>	<p>KOHLER</p>  <p>5" wrist blade</p> <p>CAT NO. DESCRIPTION KO90H 5" Pair, with indexes & screws</p>
<p>2 AMERICAN STANDARD</p>  <p>AS68H, AS69H</p> <p>CAT NO. DESCRIPTION AS66H Pair of grips, indexes, & screws (12676) AS68H Pr, complete (above deck faucets) (172) AS69H Pr, complete (below deck faucets) (372) 9AS6068 Handle screw (3 pack) 9AS6069 Skirt only, tall (above deck- #12167) 9AS6070 Skirt only, short (below deck#12181) 9AS6071 Index buttons (Pair - chrome) 9AS6072 Index rings (Pair - colored)</p>	<p>CRESTLINE</p>  <p>ALSO FITS ON PRE-2011 DELTA "DELEX" FAUCETS.</p> <p>CAT NO. DESCRIPTION CL06H Pair, with indexes & screws Hot index only Cold index only Handle Screw (each)</p>	<p>KOHLER</p>  <p>6" wrist blade</p> <p>CAT NO. DESCRIPTION 9KO2955 6" Hot only, w/ screw 9KO2954 6" Cold only, w/ screw 226C003 Handle Screw (each)</p>
<p>3 AMERICAN STANDARD</p>  <p>DE06H, 944R060</p> <p>CAT NO. DESCRIPTION DE06H Pair, w/indexes & screws (RP12491) 944R060 Red & Blue Screws only.(RP12490)</p>	<p>DELTA</p>  <p>CAT NO. DESCRIPTION EJ90H Pair, with indexes & screws EJ2188 Hot only, w/ index & screw EJ2189 Cold only, w/ index & screw</p>	<p>KOHLER</p>  <p>4" wrist blade base diam = 1-5/16"</p> <p>CAT NO. DESCRIPTION 9KO3028 Pair, with indexes & screws 9KO3027 Hot only, w/ index & screw 9KO3026 Cold only, w/ index & screw 226C003 Handle Screw (each)</p>
<p>4 AMERICAN STANDARD</p>  <p>9AS5210, 9AS5217, 9AS6073</p> <p>CAT NO. DESCRIPTION 9AS5210 ONE lever handle, buttons, & screw 9AS5217 ONE wrist blade, buttons, & screw 9AS6073 CP Bonnet nut</p>	<p>ELJER</p>  <p>CAT NO. DESCRIPTION 937C166 ONE handle. with indexes & screws 121C017 Hot index only 121C016 Cold index only</p>	<p>KOHLER</p>  <p>4" wrist blade base diam = 1-3/4"</p> <p>CAT NO. DESCRIPTION 9KO3034 Pair, with indexes & screws 9KO3033 Hot only, w/ index & screw 9KO3032 Cold only, w/ index & screw 226C003 Handle screw (each)</p>
<p>5 AMERICAN STANDARD</p>  <p>CB10H, 9CB6066, 9CB6067</p> <p>CAT NO. DESCRIPTION CB10H Pair, with indexes & screws 9CB6066 Hot index only 9CB6067 Cold index only</p>	<p>FISHER</p>  <p>CAT NO. DESCRIPTION MO6603 Hot only, w/ screw (52011) MO6604 Cold only, w/ screw (52010) MO6605 Handle Hub Kit (52002) MO6606 Ceramic cart, H (52000) MO6607 Ceramic cart, C (52001) MO6609 Torx Wrench (52005)</p>	<p>KOHLER</p>  <p>5" wrist blade</p> <p>CAT NO. DESCRIPTION KO90H 5" Pair, with indexes & screws</p>
<p>6 AMERICAN STANDARD</p>  <p>9AS6068, 9AS6069, 9AS6070, 9AS6071, 9AS6072</p> <p>CAT NO. DESCRIPTION 9AS6068 Handle screw (3 pack) 9AS6069 Skirt only, tall (above deck- #12167) 9AS6070 Skirt only, short (below deck#12181) 9AS6071 Index buttons (Pair - chrome) 9AS6072 Index rings (Pair - colored)</p>	<p>GERBER</p>  <p>CAT NO. DESCRIPTION GB06H Pair, with indexes & screws</p>	<p>KOHLER</p>  <p>6" wrist blade</p> <p>CAT NO. DESCRIPTION 9KO2955 6" Hot only, w/ screw 9KO2954 6" Cold only, w/ screw 226C003 Handle Screw (each)</p>
<p>7 CENTRAL BRASS</p>  <p>937C166, 121C017, 121C016</p> <p>CAT NO. DESCRIPTION 937C166 ONE handle. with indexes & screws 121C017 Hot index only 121C016 Cold index only</p>	<p>CHICAGO</p>  <p>CF90H, 9CF0578, 9CF0580, 227C008, 9CF0579</p> <p>CAT NO. DESCRIPTION CF90H Pair, with indexes & screws 9CF0578 Hot index only 9CF0580 Cold index only 227C008 Handle Screw (each) 9CF0579 Vandal Proof Screw (each)</p>	<p>KOHLER</p>  <p>4" wrist blade base diam = 1-3/4"</p> <p>CAT NO. DESCRIPTION 9KO3028 Pair, with indexes & screws 9KO3027 Hot only, w/ index & screw 9KO3026 Cold only, w/ index & screw 226C003 Handle Screw (each)</p>
<p>8 AMERICAN STANDARD</p>  <p>9AS6068, 9AS6069, 9AS6070, 9AS6071, 9AS6072</p> <p>CAT NO. DESCRIPTION 9AS6068 Handle screw (3 pack) 9AS6069 Skirt only, tall (above deck- #12167) 9AS6070 Skirt only, short (below deck#12181) 9AS6071 Index buttons (Pair - chrome) 9AS6072 Index rings (Pair - colored)</p>	<p>MOEN</p>  <p>CAT NO. DESCRIPTION MO6603 Hot only, w/ screw (52011) MO6604 Cold only, w/ screw (52010) MO6605 Handle Hub Kit (52002) MO6606 Ceramic cart, H (52000) MO6607 Ceramic cart, C (52001) MO6609 Torx Wrench (52005)</p>	<p>KOHLER</p>  <p>5" wrist blade</p> <p>CAT NO. DESCRIPTION KO90H 5" Pair, with indexes & screws</p>
<p>9 AMERICAN STANDARD</p>  <p>9AS6068, 9AS6069, 9AS6070, 9AS6071, 9AS6072</p> <p>CAT NO. DESCRIPTION 9AS6068 Handle screw (3 pack) 9AS6069 Skirt only, tall (above deck- #12167) 9AS6070 Skirt only, short (below deck#12181) 9AS6071 Index buttons (Pair - chrome) 9AS6072 Index rings (Pair - colored)</p>	<p>MOEN</p>  <p>CAT NO. DESCRIPTION MO6603 Hot only, w/ screw (52011) MO6604 Cold only, w/ screw (52010) MO6605 Handle Hub Kit (52002) MO6606 Ceramic cart, H (52000) MO6607 Ceramic cart, C (52001) MO6609 Torx Wrench (52005)</p>	<p>KOHLER</p>  <p>5" wrist blade</p> <p>CAT NO. DESCRIPTION KO90H 5" Pair, with indexes & screws</p>



INDIVIDUAL PARTS / FAUCET REPAIRS

OEM WRIST BLADE HANDLES (cont.)

MOEN

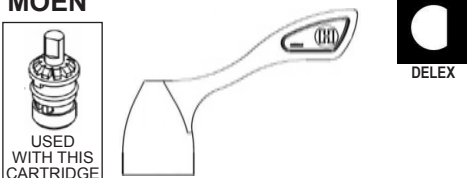

USED WITH THIS CARTRIDGE

CAT NO. MO6601
MO6602
MO6606

DESCRIPTION
Hot only, w/ Screw (121444)
Cold only, w/ screw (121443)
Torx Wrench (52005)

DELEX

SAVOY



CAT NO. SV90HX
227C007

DESCRIPTION
Pair, with indexes & screws
Handle Screw (each)

15 T

T&S BRASS



4" LONG VERSION:

CAT NO. TS90H
9TS1384
9TS1394

DESCRIPTION
Pair, w/ index & screws (generic)
Hot only, w/ index & screw (OEM)
Cold only, w/ index & screw (OEM)

20 T

MOEN

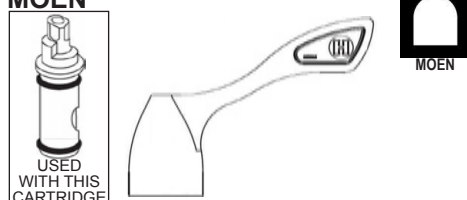

USED WITH THIS CARTRIDGE

CAT NO. MO834
MO838

DESCRIPTION
Hot only, w/ Screw (14834)
Cold only, w/ screw (14838)

MOEN

SPEAKMAN



4" LONG VERSION:

CAT NO. SP6604

DESCRIPTION
SINGLE HANDLE, index & screw

6" LONG VERSION

CAT NO. SP6606
226C003

DESCRIPTION
SINGLE HANDLE, index & screw
Handle screw

20 T

6" LONG VERSION

CAT NO. 9TS1385
9TS1395
TS173F
TS172F
227C008

DESCRIPTION
Hot only, w/ index & screw
Cold only, w/ index & screw
Hot index only
Cold index only
Handle Screw (each)

PRICE/PFISTER

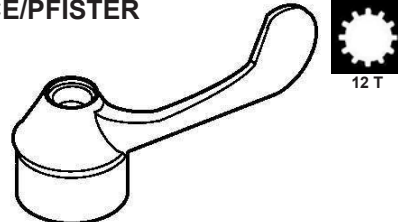

CAT NO. PF06H

DESCRIPTION
SINGLE handle, index & screw

12 T

SYMMONS

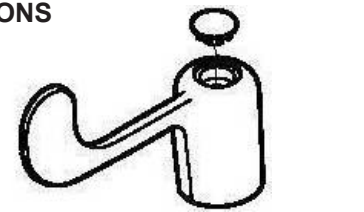

CAT NO. 947S675

DESCRIPTION
Wrist handle, single

WATERSAVER FAUCET

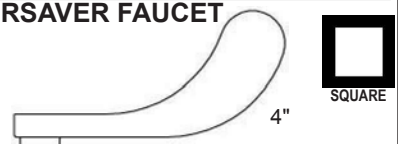

CAT NO. WS06H
121C043
121C042
227C002

DESCRIPTION
SINGLE handle, index & screw
Hot index only
Cold index only
Handle screw

4"

SQUARE

ZURN



CAT NO. ZR90H

DESCRIPTION
Pair, with indexes & screws

8 T

SINGLE LEVER & KNOB FAUCET HANDLES

AMERICAN STANDARD

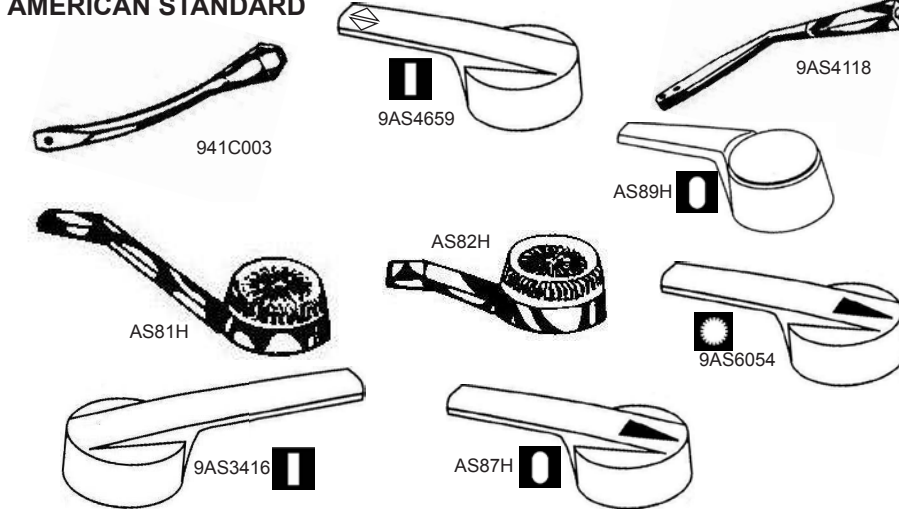

CAT NO. 941C003
9AS4118
9AS3416
9AS4659
AS81H
AS82H
AS87H
AS89H

DESCRIPTION
Older single lever lav
Older single lever kitchen
Fiesta single lever kitchen
Aquarian II lav & shower
Shower Thermo Guard
Aquarian kitchen
Aquarian lav
Tub/Shower
Tub/Shower

OEM 72547
61228
37982
70545
70613
77031
77033
10889
50081

LENGTH 4-1/2"
4-1/2"
5-3/4"
4"
4-1/8"
6-1/4"
4-1/2"
4-1/8"
3-3/8"

DELTA

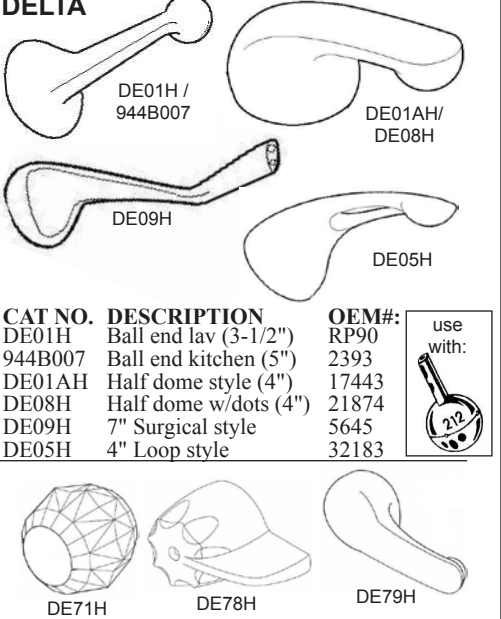

CAT NO. DE01H / 944B007
DE01AH / DE08H
DE09H
DE05H

DESCRIPTION
Ball end lav (3-1/2")
Ball end kitchen (5")
Half dome style (4")
Half dome w/dots (4")
7" Surgical style
4" Loop style

OEM#: RP90
2393
17443
21874
5645
32183

OTHER AM/STD HANDLES ARE AVAILABLE. PLEASE ORDER BY OEM NUMBER.

DE71H Round Knob
DE78H Wedge Handle
DE79H Lever Handle



INDIVIDUAL PARTS / FAUCET REPAIRS

SINGLE LEVER & KNOB FAUCET HANDLES (cont.)

ELJER

EJ01H
EJ05H
EJ04H

CAT NO.	DESCRIPTION	OEM
EJ05H	Lever style, 2001+	H116

ELKAY

EK01H

CAT NO.	DESCRIPTION	OEM
EK01H	Lever style,	53080

GERBER

See details for Gerber handles on page 1-50

KOHLER
Use these handles with THIS cartridge:

KO52H
KO51H
KO53H
KO54H

CAT NO.	DESCRIPTION	OEM
KO51H	Knob	77338
KO52H	Loop lever	1005588
KO53H	Long lever	1001795
KO54H	Lever	1001796

KOHLER
Use these handles with THIS cartridge:

KO56H
KO57H

CAT NO.	DESCRIPTION	OEM
KO55H	Knob	30416
KO56H	Lever, screw, insert	30423/71610
KO57H	Flat lever only	71535

MIXET

9MX0060
9MX0029
9MX0031
9MX0009
9MX0030
9MX0011

CAT NO.	DESCRIPTION	OEM
9MX0060	Loop temp handle	MLH-HH
9MX0029	Clear round handle	MRH-CLR
9MX0031	Clear temp handle	MTH-CLR
9MX0009	Metal round handle	MRH-MET
9MX0030	Metal temp. handle	MLH-MET
9MX0011	Plastic temp. handle	MLH-CP

MOEN
Use these handles with THIS cartridge:

MO06H
MO07H
MO0258
MO08H

LAV: SHORT INSERT SHOWER: LONG INSERT

CAT NO.	DESCRIPTION	OEM
MO06H	Economy Round knob (tub/shower)	
MO07H	Economy Round knob (lav)	
9MO0258	Oval knob for tub/shower	96797
MO08H	Economy version of above	
9MO0259	Oval knob for lav	13103
MO09H	Economy version of above	

MOEN
Use these handles with THIS cartridge:

MO02H
MO32H
MO39H
MO34H
MO40H

CAT NO.	DESCRIPTION	OEM
MO02H	Lever for Chateau lav	13393
MO32H	Lever for Chateau shower	13499
MO39H	Lever for Chateau	100224
MO34H	Lever for Chateau	100657
MO40H	Lever for Chateau	94740

MOEN
Use these handles with THIS cartridge:

MO33H
MO34H
MO38H
MO37H

CAT NO.	DESCRIPTION	OEM
MO33H	Knob for Posi-temp	96884
MO34H	Lever for Posi-temp	100657
MO38H	Lever for Posi-temp	14732
MO37H	Lever for Moentrol	13291

PRICE PFISTER
Use these handles with THIS cartridge:

9PF1101
9PF1102
227C016
9PF1100

PF65H

9PF1103
9PF1104
9PF1100

PF66H

9PF1105
9PF1106
9PF1109
9PF1107

PF67H

9PF1105
9PF1106
9PF1109
9PF1108

PF68H

CAT NO.	DESCRIPTION	OEM
PF65H	Loop handle kit complete	disc.
PF66H	VP Loop handle kit complete	disc.
PF67H	Solid handle kit complete	
PF68H	Loop handle kit complete	disc.
9PF1100	Loop handle	940-145 disc.
9PF1101	Button insert	941-960
9PF1102	Label for button	941-970
9PF1103	Insert spacer	941-345
9PF1104	VP screw	971-966
9PF1105	Labels	940-805
9PF1106	Adapter screw	970-800
9PF1107	Solid handle	940-800
9PF1108	Loop handle	940-997 disc.
9PF1109	Set Screw	971-130
227C016	Handle screw	971-860



INDIVIDUAL PARTS / FAUCET REPAIRS

SINGLE LEVER & KNOB FAUCET HANDLES (cont.)

SAVOY

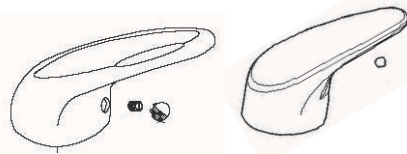

CAT NO.	DESCRIPTION	OEM
SV6011	Loop handle	X031515
121C049	Index for loop handle	
SV6012	Solid handle	X030516
	Index for solid handle	

SYMMONS

These handles are used on various Symmons lav faucets.

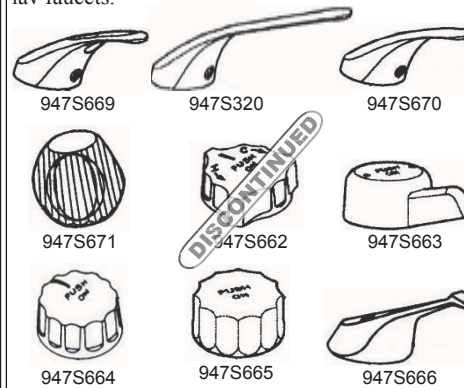

947S669	947S320	947S670
947S671	947S662	947S663
947S664	947S665	947S666

CAT NO.	FOR FAUCET:	OEM
947S669	S-20 Series (loop)	KN-3BRB
947S371	S-20 Series	LN-135
947S670	S-20 Series (solid)	KN-3RB
947S661	S-20 Series	LN-122
947S662	S-60 Scot 1984-2000	LL-18
947S663	S-60 Scot 2000+	LL-104
947S664	S-61 1994-2000	LT-37
947S665	S-61 2001+	LT-100
947S666	Temptrol 1974-1999	L-2

VALLEY

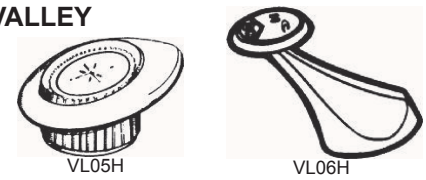

CAT NO.	DESCRIPTION:
VL05H	Lucite Handle
VL06H	Metal Handle

Notes:



SYMMONS

These handles are interchangeable on Symmons' Temptrol shower valves.

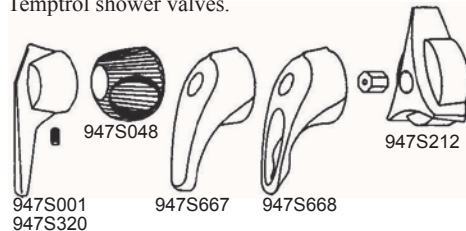

CAT NO.	DESCRIPTION	OEM
947S001	Lever handle (fits C-5)	(RC-14)
947S320	Lever handle (fits TA-10)	(RC-14X)
947S048	Knob handle	(T-101)
947S667	Lever handle	(T3-31S)
947S668	Lever handle	(T3-31L)
947S212	Triangle handle	(T-31)

FAUCET HANDLES

ACORN



HOT: **9AN0003**
COLD: **9AN0002**
SCREW: **9AN0001**
USED ON:
2 temperature
Flo-Cloz Valves

ACORN

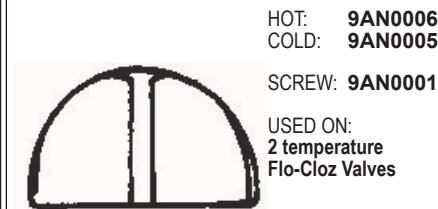

HOT: **9AN0006**
COLD: **9AN0005**
SCREW: **9AN0001**
USED ON:
2 temperature
Flo-Cloz Valves

Tip to Tip dimension: **2-3/8"**



**ALL HANDLES
PACKED WITH
SCREWS & INDEXES
(WHERE APPLICABLE)**

ACORN



SINGLE: **9AN0004**
SCREW: **9AN0001**
USED ON:
SINGLE temperature
Flo-Clos valves

ACORN

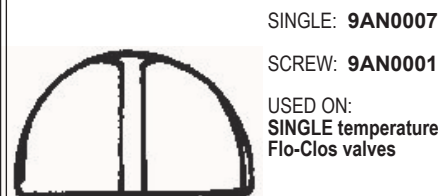

SINGLE: **9AN0007**
SCREW: **9AN0001**
USED ON:
SINGLE temperature
Flo-Clos valves

ACORN

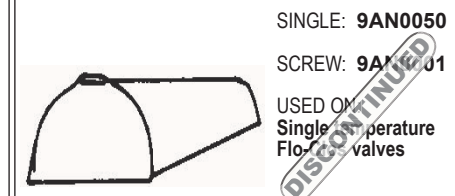

SINGLE: **9AN0050**
SCREW: **9AN0001**
USED ON:
SINGLE temperature
Flo-Clos valves

AMERICAN KITCHENS



PAIR: **AK01H**
HOT: **AK280**
COLD: **AK280**
USED ON:
LF100C Back Mount Sink

Tip to Tip dimension: **2-5/16"**

AMERICAN KITCHENS



PAIR: **AK02AH**
HOT: **AK288**
COLD: **AK288**
USED ON:
LF210 Back Mount Sink

Tip to Tip dimension: **2-1/8"**

AMERICAN KITCHENS

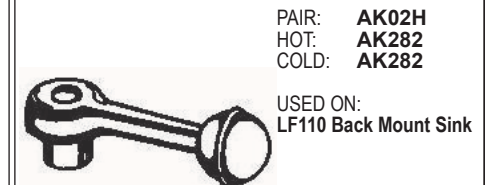











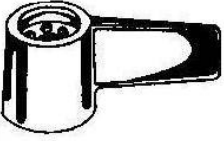



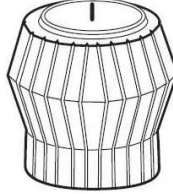
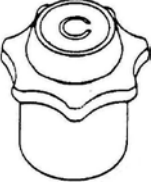

PAIR: **AK02H**
HOT: **AK282**
COLD: **AK282**
USED ON:
LF110 Back Mount Sink

Tip to Tip dimension: **2-5/16"**

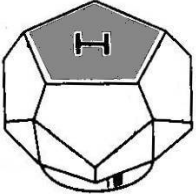
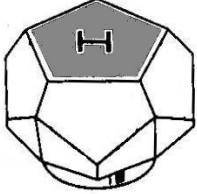

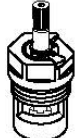
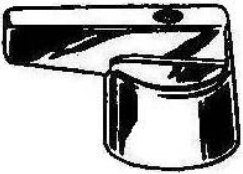
INDIVIDUAL PARTS / FAUCET REPAIRS

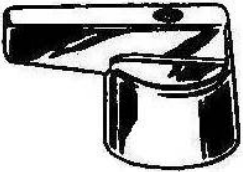
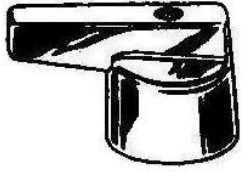
FAUCET HANDLES (cont.)

<p>AMERICAN STANDARD SINGLE: 9AS0395 CAP: 948A031 USED ON: Drinking fountains</p>  <p>Tip to Tip dimension: 2-5/8"</p>	<p>AMERICAN STANDARD PAIR: AS04H HOT: AS355 COLD: AS354 SCREW: 227C002</p>  <p>Tip to Tip dimension: 2"</p>	<p>AMERICAN STANDARD PAIR: AS03H HOT: AS353 COLD: AS352 SCREW: 227C002</p>  <p>Tip to Tip dimension: 2"</p>
<p>AMERICAN STANDARD PAIR: AS08H SCREW: 227C002 USED ON: R40 & R41 Ledge Sink Faucets</p>  <p>Tip to Tip dimension: 2-1/2"</p>	<p>AMERICAN STANDARD AS18AH (OEM Handle pair) AS18AHX (Economy Handle pair with adapters) SCREW: 227C002 USED ON: Colony Faucets</p>  <p>Tip to Tip dimension: 1-3/8"</p>	<p>AMERICAN STANDARD SINGLE: AS64H OEM: 68614 Base Diameter: 2" Tip to Tip dimension: 2-5/8"</p> 
<p>AMERICAN STANDARD PAIR: AS77HS SCREW: 227C002 USED ON: 4" Lavs & most kitchen faucets</p>   <p>FOR AQUASEAL</p> <p>Tip to Tip dimension: 2"</p>	<p>AMERICAN STANDARD PAIR: AS77H SCREW: 227C002 USED ON: Widespread lav faucets</p>   <p>FOR AQUASEAL</p> <p>Tip to Tip dimension: 2-1/4"</p>	<p>AMERICAN STANDARD PAIR: AS77HL SCREW: 227C002 USED ON: Shower valves</p>   <p>FOR AQUASEAL</p> <p>Tip to Tip dimension: 2-3/4"</p>
<p>AMERICAN STANDARD PAIR: AS57H SCREW: 227C002 USED ON: 4" Lavs</p>  <p>Tip to Tip dimension: 2-1/4"</p>	<p>AMERICAN STANDARD PAIR: AS67H DIV: AS67HD SCREW: 227C002 USED ON: Shower Valves</p>  <p>Tip to Tip dimension: 2-5/8"</p>	<p>AMERICAN STANDARD PAIR: AS88H EACH: AS178H USED ON: Lav faucets w/ ceramic cartridges</p>   <p>FOR CERAMICS</p>
<p>AMERICAN STANDARD PAIR: AS13H HOT: AS363 COLD: AS362 DIV: 9AS4321 SCREW: 227C002 USED ON: R-4000 series faucets, R-2100 slant back (non- renu), and shower valves.</p>  <p>Base Diameter: 1-3/8" Tip to Tip dimension: 2-3/8"</p>	<p>AMERICAN STANDARD SINGLE: AS63H OEM: 50074 Height: 2-1/2" Tip to Tip dimension: 2-1/2"</p> 	<p>AMERICAN STANDARD PAIR: AS71H (oem 142H) USED ON: Above Deck Faucets PAIR: AS72H (oem 342H) USED ON: Below Deck Faucets</p> 
<p>AMERICAN STANDARD PAIR: AS07H HOT: AS359 COLD: AS358 SCREW: 227C002 USED ON: R-4100 series ledge sink faucets (non-renu)</p>  <p>Base Diameter: 1-1/2" Tip to Tip dimension: 2-1/4"</p>	<p>AMERICAN STANDARD PAIR: AS07HX (Economy Handle pair with adapters) SCREW: 227C002 USED ON: R-4100 series ledge sink faucets (non-renu)</p>  <p>Base Diameter: 1-1/2" Tip to Tip dimension: 2-1/4"</p>	<p>AMERICAN STANDARD PAIR: AS65H (oem 152H) USED ON: Above Deck Faucets</p>   <p>FOR CERAMICS</p>



INDIVIDUAL PARTS / FAUCET REPAIRS

FAUCET HANDLES (cont.)

AMERICAN STANDARD

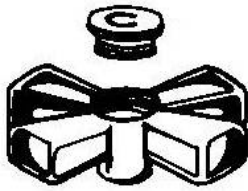

PAIR: **AS12H**
DIV: **AS12HD**

SCREW: **227C002**

HOT INDEX: **939C004**
COLD INDEX: **939C003**
BLANK INDEX: **9AS0827**

USED ON:
Showers & Widespreads

Tip to Tip dimension: **2-3/4"**

AMERICAN STANDARD

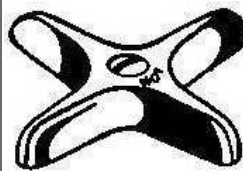

PAIR: **AS12AH**
(economy pair)

SCREW: **227C002**

USED ON:
Showers & Widespreads

Tip to Tip dimension: **2-1/2"**

AMERICAN STANDARD

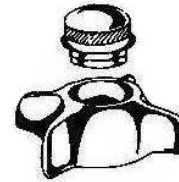

SINGLE: **948A028**

CAP: **948A031**

USED ON:
Drinking Fountains

Tip to Tip dimension: **2-13/16"**

AMERICAN STANDARD

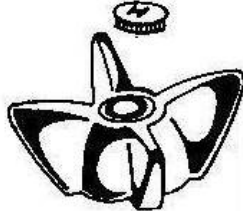

PAIR: **AS36H**

SCREW: **227C002**

HOT INDEX: **121C075**
COLD INDEX: **121C076**

USED ON:
Colony Bath & Shower

Tip to Tip dimension: **3"**

AMERICAN STANDARD

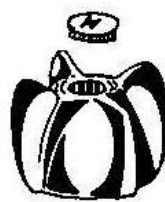

PAIR: **AS18H**

SCREW: **227C002**

HOT INDEX: **121C075**
COLD INDEX: **121C076**

USED ON:
Colony Lav Faucets

Tip to Tip dimension: **2-1/16"**

AMERICAN STANDARD



EACH: **9AS9623**
(Metering Handle with set screw and indexes)

INDEXES & SET SCREW:
9AS6239

USED ON:
Push button metering faucets

9AS9623

AMERICAN STANDARD

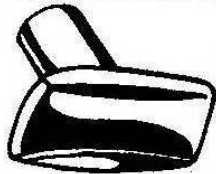

SINGLE: **9AS2622**

SCREW: **9AS2650**

USED ON:
Push-Pull Shower Valves

Side to Side dimension: **3"**

AMERICAN STANDARD



Old style Push-Pull shower handle, replaced by **9AS2622**

AMERICAN STANDARD



PAIR: **AS35H**
HOT: **AS365**
COLD: **AS364**

DIV: **AS35HD**

SCREW: **227C002**

USED ON:
Traciline Bath and shower valves

Tip to Tip dimension: **2-5/8"**

AMERICAN STANDARD



Old style Push-Pull shower handle, replaced by **9AS1473**

AMERICAN STANDARD

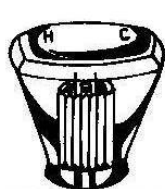

SINGLE: **9AS1473**

INDEX: **121C057**

USED ON:
Push-Pull Lavs

Side to Side dimension: **2"**

AMERICAN STANDARD



HOT: **9AS2083**
COLD: **9AS2082**

SCREW: **9AS2650**

USED ON:
Self Closing Metering

Side to Side dimension: **1-1/4"**

AMERICAN STANDARD



SINGLE: **941C003**

USED ON:
Single Lever Lav

Tip to Tip dimension: **4-1/2"**

AMERICAN STANDARD

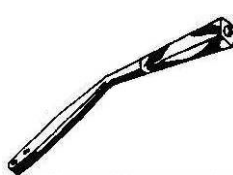

SINGLE: **9AS4118**

USED ON:
Single Control Sinks

Tip to Tip dimension: **5-3/4"**

INDIVIDUAL INDEXES ARE SHOWN ON PAGES 1-62 - 1-64

MEASURE LIKE THIS:

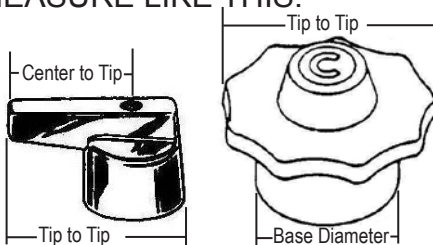



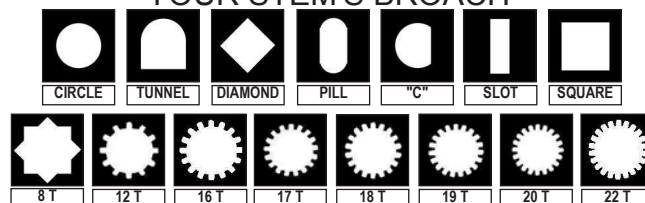





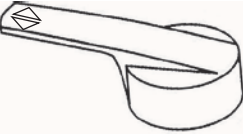



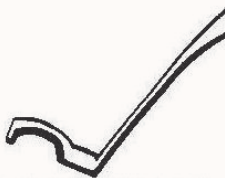

USE THIS CHART TO IDENTIFY YOUR STEM'S BROACH

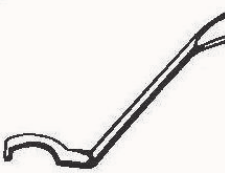

INDIVIDUAL PARTS / FAUCET REPAIRS

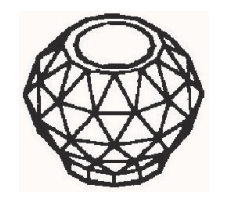
FAUCET HANDLES (cont.)

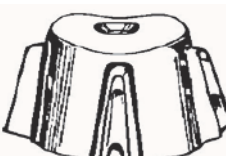
<p>AMERICAN STANDARD SINGLE: 9AS4659 USED ON: Aquarian II Lav & Shower OEM: 70545</p>  <p>Tip to Tip dimension: 4"</p>	<p>AMERICAN STANDARD SINGLE: AS82H USED ON: Aquarian Lav OEM: 77033</p>  <p>Tip to Tip dimension: 3-1/4"</p>	<p>AMERICAN STANDARD SINGLE: AS81H USED ON: Aquarian Shower OEM: 77031</p>  <p>Tip to Tip dimension: 5"</p>
<p>AMERICAN STANDARD SINGLE: 9AS3416 USED ON: Fiesta Kitchen OEM: 37982</p>  <p>Tip to Tip dimension: 5-3/4"</p>	<p>AMERICAN STANDARD SINGLE: AS87H USED ON: Tub & Shower OEM: 10889</p>  <p>Tip to Tip dimension: 4-1/8"</p>	<p>AMERICAN STANDARD SINGLE: AS89H USED ON: Tub & Shower OEM: 50081</p>  <p>Tip to Tip dimension: 3-3/8"</p>
<p>AMERICAN STANDARD SINGLE: 9AS6054 USED ON: Thermoguard Tub & Shower OEM: 70613</p>  <p>Tip to Tip dimension: 4-1/8"</p>	<p>BRADLEY-COLE SINGLE: 928C401 USED ON: Sceptre & Cascade kitchen faucets</p>  <p>Tip to Tip dimension: 5-3/4"</p>	<p>BRADLEY-COLE SINGLE: 928C410 INDEX: 928C410 SCREW: 227C008 USED ON: Sceptre & Cascade kitchen, lav, and bath faucets USE 928C426</p>  <p>Center to Tip dimension: 1-3/8"</p>
<p>BRADLEY-COLE SINGLE: 928C426 USED ON: Single lever kitchen, lav, and bath faucets</p>  <p>Center to Tip dimension: 1-1/2"</p>	<p>BRADLEY-COLE SINGLE: 928C400 USED ON: Sceptre & Cascade lav faucets</p>  <p>Tip to Tip dimension: 4-5/8"</p>	<p>BRIGGS PAIR: BR01H HOT: BR893 COLD: BR892 SCREW: 227C008</p>  <p>Center to Tip dimension: 2-5/8"</p>
<p>BRIGGS / SAYCO PAIR: BR04H HOT: BR891 COLD: BR890 SCREW: 227C008 USED ON: T-9220 Back mount sink</p>  <p>Center to Tip dimension: 2-1/4"</p>	<p>BRIGGS / SAYCO PAIR: BR10H HOT: BR897 COLD: BR896 SCREW: 227C008 USED ON: t-880, 8805, 8820 series lav faucets</p>  <p>Center to Tip dimension: 2-1/4"</p>	<p>BRIGGS / SAYCO PAIR: SC36H HOT: SC6971 COLD: SC6970 SCREW: 227C008 USED ON: 4" Lavs & most kitchen faucets</p>  <p>Height: 2-1/4" Tip to Tip dimension: 1-3/4"</p>
<p>BRIGGS / SAYCO PAIR: BR30H DIV: BR30HD H INDEX: 939C003 C INDEX: 939C004 USED ON: Lav and shower valves</p>  <p>Tip to Tip dimension: 3"</p>	<p>BRIGGS / SAYCO PAIR: BR30AH (economy pair) USED ON: Lav and shower valves</p>  <p>Tip to Tip dimension: 2-1/2"</p>	<p>BRIGGS / SAYCO HOT: BR903 COLD: BR904 (similar to picture) USED ON: Trimline shower valves</p> 



INDIVIDUAL PARTS / FAUCET REPAIRS



























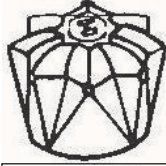

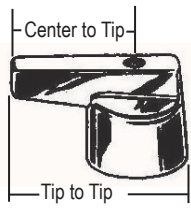

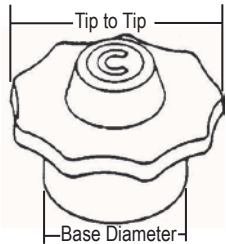

FAUCET HANDLES (cont.)

<p>BROADWAY</p>  <p>SINGLE: 9BW0001 (CP) 9BW0005 (PB)</p> <p>USED ON: Broadway and T&S Brass faucets</p>	 <p>FLANGE: 9BW0002 (PB) RING: 9BW0003 (PB)</p> <p>USED ON: Broadway and T&S Brass faucets</p> <p>FLANGE & RING TOGETHER</p>	<p>CENTRAL BRASS</p>  <p>PAIR: CB06H HOT: CB11055 COLD: CB11054</p> <p>SCREW: 227C008</p> <p>Center to Tip dimension: 1-3/4"</p>
<p>CENTRAL BRASS</p>  <p>PAIR: CB07H</p> <p>SCREW: 227C008</p> <p>USED ON: Superseat sinks and old model faucets</p> <p>Center to Tip dimension: 1-3/4"</p>	<p>CENTRAL BRASS</p>  <p>PAIR: CB30H DIV: CB30HD</p> <p>SCREW: 227C008</p> <p>USED ON: Shower and bath valves</p> <p>Tip to Tip dimension: 2-3/4"</p>	<p>CENTRAL BRASS</p>  <p>PAIR: CB05H</p> <p>SCREW: 227C008</p> <p>USED ON: Ledge and concealed sink faucets</p> <p>Center to Tip dimension: 2-3/16"</p>
<p>CENTRAL BRASS</p>  <p>PLAIN: 949I215 HOT: 949I214 COLD: 949I213</p> <p>SCREW: 227C008</p> <p>USED ON: Push-on faucets</p>	<p>CENTRAL BRASS</p>  <p>HOT: CB11060 COLD: CB11059</p> <p>SCREW: 227C008</p> <p>USED ON: Widespread Lav's</p> <p>Tip to Tip dimension: 3"</p>	<p>CENTRAL BRASS</p>  <p>PAIR: CB04H</p> <p>SCREW: 227C008</p> <p>USED ON: Lav, Bath, Shower</p>
<p>CENTRAL BRASS</p>  <p>PAIR: CB34H</p> <p>SCREW: 227C008</p> <p>USED ON: Lav, Bath, Shower</p> <p>Tip to Tip dimension: 1-15/16"</p>	<p>CHICAGO FAUCET</p>  <p>PAIR: CF01H</p> <p>RED RING: 9CF0578 BLUE RING: 9CF0580</p> <p>SCREW: 227C008</p> <p>USED ON: All Chicago faucets</p> <p>Tip to Tip dimension: 2-1/4"</p>	<p>CHICAGO FAUCET</p>  <p>PAIR: CF03H</p> <p>RED RING: 9CF0578 BLUE RING: 9CF0580</p> <p>SCREW: 227C008</p> <p>USED ON: All Chicago faucets</p>
<p>CHICAGO FAUCET</p>  <p>PLAIN: 949F219 (includes red, blue, and white buttons)</p> <p>SET OF COLORED BUTTONS: 9CF3360</p> <p>USED ON: MVP Cartridges</p>	 <p>ALL HANDLES PACKED WITH SCREWS & INDEXES (WHERE APPLICABLE)</p>	<p>CHICAGO FAUCET (DUCK BILL)</p>  <p>HOT: 9CF3358 COLD: 9CF3357 PLAIN: 9CF3359</p> <p>USED ON: 335X Cartridges (9CF1007)</p>
<p>CHICAGO FAUCET</p>  <p>PAIR: CF02H</p> <p>COLD: CF1230 HOT: CF1231</p> <p>SCREW: 227C008</p> <p>USED ON: All Chicago faucets</p>	<p>CHICAGO FAUCET</p>  <p>PAIR: CF07H</p> <p>SCREW: 227C008</p> <p>USED ON: New style and old style faucets</p>	<p>CHICAGO FAUCET (TIP TAP)</p>  <p>HOT: 9CF0353 COLD: 9CF0357 PLAIN: 9CF0358</p> <p>USED ON: 335X Cartridges (9CF1007)</p>



INDIVIDUAL PARTS / FAUCET REPAIRS

FAUCET HANDLES (cont.)

<p>CRANE</p> <p>PAIR: CR03H</p> <p>HOT: CR16002⁽⁹⁰⁴³⁾ COLD: CR16003⁽⁹⁰⁴⁴⁾</p> <p>SCREW: 227C015</p> <p>USED ON: Capri faucets</p>  <p>USE WITH  DIALEZE</p> <p>Center to Tip dimension: 1-11/16"</p> <p>OLD STYLE </p>	<p>CRANE</p> <p>PAIR: CR03HX (Economy handle pair with adapters)</p> <p>SCREW: 227C015</p> <p>USED ON: Capri faucets</p>  <p>USE WITH  DIALEZE</p> <p>Center to Tip dimension: 1-11/16"</p> <p>OLD STYLE </p>	<p>CRANE</p> <p>PAIR: CR04H</p> <p>HOT: CR16017⁽⁹⁰⁴⁵⁾ COLD: CR16018⁽⁹⁰⁴⁶⁾</p> <p>SCREW: 227C015</p> <p>USED ON: Capri faucets</p>  <p>USE WITH  DIALEZE</p> <p>Center to Tip dimension: 2"</p> <p>OLD STYLE </p>
<p>CRANE</p> <p>PAIR: CR30H (16797cl 16795h)</p> <p>SCREW: 226C002</p> <p>USED ON: Riviera lav faucets</p>  <p>Base Diameter: 1-7/8"</p>	<p>CRANE</p> <p>HOT: 9CR2010⁽¹⁶⁷⁹⁹⁾ COLD: 9CR2011⁽¹⁶⁸⁰¹⁾</p> <p>SCREW: 226C002</p> <p>USED ON: Riviera widespread faucets</p>  <p>Base Diameter: 2-1/8"</p>	<p>CRANE</p> <p>PAIR: CR31H</p> <p>HOT: 9CR2060⁽¹⁷⁶³⁴⁾ GOLD: 9CR2061⁽¹⁷⁶³⁴⁾ DIV: 9CR2015⁽¹⁶⁸¹⁰⁾ (3/8" diameter broach)</p> <p>SCREW: 226C002</p> <p>USED ON: Riviera bath and shower</p>  <p>Base Diameter: 2-1/2"</p>
<p>CRANE</p> <p>PAIR: CR32H</p> <p>HOT: CR16031⁽⁸³⁷⁴⁾ COLD: CR16032⁽⁸³⁷⁵⁾</p> <p>H INDEX: 121C059 C INDEX: 121C058 BLANK INDEX: 9CR1168</p> <p>USED ON: Hospital lav, bath, and shower</p>  <p>USE WITH  DIALEZE</p> <p>Tip to Tip dimension: 2-3/4"</p>	<p>CRANE</p> <p>SINGLE: 9CR1466⁽⁹⁰⁶²⁾</p> <p>USED ON: Magic-close faucets</p>  <p>Base Diameter: 1-5/8"</p>	<p>CRANE</p> <p>PAIR: 9CR2014 (1/2" diameter broach)</p> <p>SCREW: 226C002</p> <p>USED ON: Riviera bath and shower</p>  <p>Base Diameter: 2-1/2"</p>
<p>CRANE</p> <p>HOT: 9CR2429⁽¹¹³⁶⁴⁾ COLD: 9CR2430⁽¹¹³⁶⁵⁾</p> <p>H INDEX: 121C093 C INDEX: 121C094</p> <p>USED ON: Riviera lav faucets</p>  <p>Tip to Tip dimension: 2-5/16"</p>	<p>CRANE</p> <p>USE: 9CR2378 / 79 HOT: 9CR2432⁽¹⁷⁰⁴⁷⁾ GOLD: 9CR2431⁽¹⁴³⁶⁹⁾ DIV: 9CR2433⁽¹⁶⁸¹⁰⁾</p> <p>H INDEX: 121C093 C INDEX: 121C094</p> <p>USED ON: Riviera bath and shower</p>  <p>Replaced with 5 wing handle </p> <p>Tip to Tip dimension: 2-7/8"</p>	<p>MEASURE LIKE THIS:</p>  <p>Center to Tip Tip to Tip</p>
<p>CRANE</p> <p>HOT: 9CR2524⁽¹¹⁰⁶⁷⁾ COLD: 9CR2525⁽¹¹⁰⁶⁸⁾</p> <p>H INDEX: 121C063 C INDEX: 121C062</p> <p>USE WITH  DIALEZE</p> <p>Base Diameter: 1-7/16"</p> 	<p>CRANE</p> <p>USE: 9CR2378 / 79 HOT: 9CR2522⁽¹¹⁰⁶⁵⁾ GOLD: 9CR2523⁽¹¹⁰⁶⁶⁾</p> <p>H INDEX: 121C063 C INDEX: 121C062</p> <p>USE WITH  DIALEZE</p> <p>Replaced with 5 wing handle </p> <p>Base Diameter: 1-3/4"</p> 	 <p>Tip to Tip Base Diameter</p>
<p>CRANE</p> <p>USE: 9CR1466 HOT: 9CR1838⁽¹⁴⁸¹⁶⁾ GOLD: 9CR1839⁽¹⁴⁸¹⁷⁾</p> <p>SCREW: 226C002</p> <p>USED ON:</p> <p>Replaced with X top handle </p> <p>USE WITH  DIALEZE</p> <p>Tip to Tip dimension: 1-1/2"</p> 	<p>CRANE</p> <p>HOT: 9CR2378⁽⁹⁴⁰¹⁾ COLD: 9CR2379⁽⁹⁴⁰²⁾</p> <p>SCREW: 226C002</p> <p>USED ON: Capri widespread faucets</p> <p>USE WITH  DIALEZE</p> <p>Tip to Tip dimension: 1-3/4"</p> 	<p>CRANE</p> <p>SINGLE: 9CR1914⁽¹⁵¹⁷⁵⁾</p> <p>SCREW: 227C007</p> <p>USED ON: Dialette lav faucets  (with this cartridge)</p> <p>Tip to Tip dimension: 1-3/4"</p> 



INDIVIDUAL PARTS / FAUCET REPAIRS

FAUCET HANDLES (cont.)

CRANE



HOT: **9CR1655**⁽¹⁴¹⁶⁰⁾
COLD: **9CR1654**⁽¹⁴¹⁵⁹⁾

SCREW: **227C015**

USED ON:
Riviera lav faucets
(16 point broach only)

Tip to Tip dimension: **3"**

CRANE



HOT: ~~**9CR1864**~~⁽¹⁴⁴⁵²⁶⁾
GOLD: ~~**9CR1862**~~⁽¹⁴⁴⁹⁹³⁾

SCREW: **227C015**

USED ON:
Riviera lav faucets

CRANE



USE: **CR31H**
PAIR: ~~**CR37H**~~
HOT: ~~**9CR1863**~~⁽¹⁴⁴⁹⁹⁵⁾
GOLD: ~~**9CR1864**~~⁽¹⁴⁴⁹⁹⁷⁾

SCREW: **227C015**

USED ON:
Riviera bath & shower

CRANE

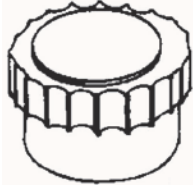

HOT: **9CR2526**⁽¹¹⁰⁷²⁾
COLD: **9CR2527**⁽¹¹⁰⁷²⁾

SCREW: **227C010**

USED ON:
Crestmont lav faucets

Tip to Tip dimension: **2"**

CRANE



PAIR: **CR33H**
HOT: **CR16023**⁽¹⁴⁵³⁶⁾
COLD: **CR16027**⁽¹⁴⁵³⁷⁾

SCREW: **227C010**

USED ON:
Crestmont lav faucets

Tip to Tip dimension: **2"**

CRANE



PAIR: **CR34H**
HOT: **9CR1788**⁽¹⁴⁵³⁴⁾
COLD: **9CR1789**⁽¹⁴⁵³⁵⁾

SCREW: **227C015**

USED ON:
Crestmont bath & shower

Tip to Tip dimension: **2-3/4"**

CRANE

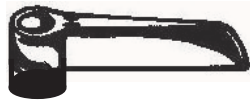

HOT: **9CR2239**⁽⁸³⁹¹⁾
COLD: **9CR2240**⁽⁸³⁹²⁾

CRANE

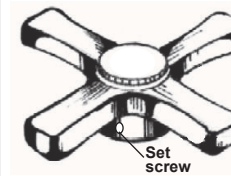

HOT: **9CR2258**⁽⁸⁵¹⁷⁾
COLD: **9CR2259**⁽⁸⁵¹⁸⁾

CRESTLINE

Every kit includes either hot & cold, or diverter handle, plus: matching brass broach inserts, screws, & porcelain buttons.



CRESTLINE



PAIR: **CT01H**

USED ON:
Crestline commercial mop sink faucets

CRESTLINE



SINGLE: **CL10H**

USED ON:
Crestline Delex style single handled lav

Tip to Tip dimension: **2-3/4"**

H & C

CAT NO:
VP601
VP602
VP603
VP604
VP605
VP606
VP607
VP608
VP609
VP610

DIVERTER

CAT NO:
VP651
VP652
VP653
VP654
VP655
VP656
VP657
VP658
VP659
VP660

MFR:
American Std
Briggs
Central Brass
Chicago
Gerber
Kohler
Price Pfister
Repcal
Savoy
Sayco

CRESTLINE



SINGLE: **CL01H**

USED ON:
Crestline Delex style single handled lav

Base Diameter: **1-3/4"**
Tip to Tip dimension: **4"**

CRESTLINE



SINGLE: **CL03H**

USED ON:
Crestline Delex style single handled kitchen

Base Diameter: **1-7/8"**
Tip to Tip dimension: **5-3/8"**

From this...



To this...



CRESTLINE



PAIR: **CL02H**
HOT: **CL3001**
COLD: **CL3002**

USED ON:
Crestline Delex style 2 handled lav and kitchen

CRESTLINE



PAIR: ~~**CL96H**~~
PAIR: ~~**CL96H**~~ CARTRIDGES:
~~**CL96HX**~~

USED ON:
Crestline Deco style 2 handled lav and kitchen

Center to Tip dimension: **3"**

Note: Must be used with cartridges shown at right.

CRESTLINE

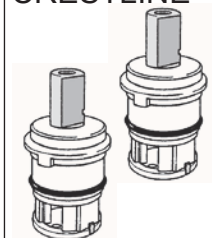

H & H: **CL96ATG**
H & C: **CL96TG**











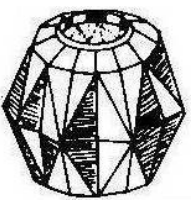

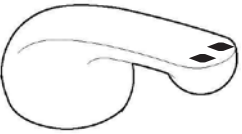

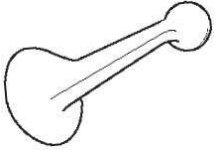
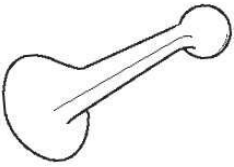
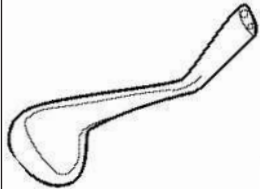
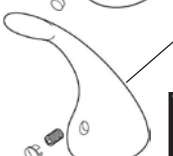
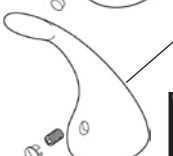

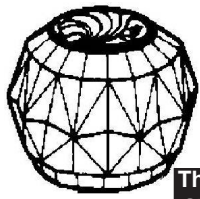
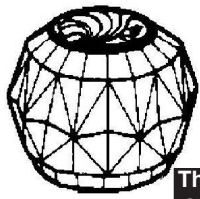
USED ON:
Crestline Deco style 2 handled lav and kitchen

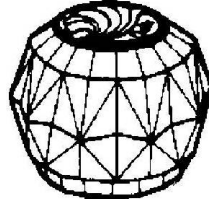
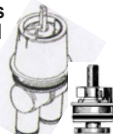
Note: These cartridges have integrated stops to keep handles from free spinning. Use with CL96H handles

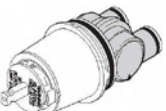

INDIVIDUAL PARTS / FAUCET REPAIRS

FAUCET HANDLES (cont.)

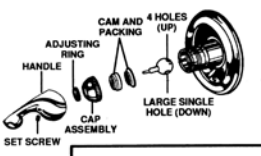
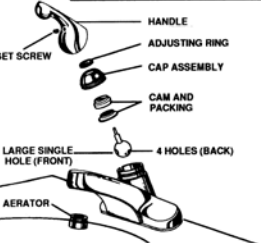
<p>DELTA</p>  <p>PAIR: DX01H (oem H28)</p> <p>USED ON: 2 handled Lav and kitchen faucets</p>	<p>DELTA</p>  <p>PAIR: 944B088 (oem RP2390/H41)</p> <p>USED ON: 2 handled widespread faucets</p> <p>Tip to Tip dimension: 2-1/4"</p>	<p>DELTA</p>  <p>PAIR: DX02H (oem H21)</p> <p>USED ON: 2 handled Lav and kitchen faucets</p>
<p>DELTA</p>  <p>SINGLE: DE05H (Loop style) (oem RP32183)</p> <p>USED ON: Lav and kitchen faucets</p> <p>Tip to Tip dimension: 5-1/4"</p>	<p>DELTA</p>  <p>SINGLE: DE08H (Half Dome Style, with red & blue dots) (oem RP21874)</p> <p>SINGLE: DE01AH (Half Dome Style, less dots) (oem RP17743)</p> <p>USED ON: Lav faucets</p> <p>Tip to Tip dimension: 4"</p>	<p>DELTA</p>  <p>PLAIN: DE32HP (oem RP5212)</p> <p>USED ON: Push valves using this cartridge:</p> 
<p>DELTA</p>  <p>SINGLE: DE01H (Loop style) (oem RP90)</p> <p>USED ON: Lav and kitchen faucets</p> <p>Tip to Tip dimension: 3-5/8"</p>	<p>DELTA</p>  <p>SINGLE: 944B007 (Dome Style) (oem RP2393)</p> <p>USED ON: Kitchen faucets</p> <p>Tip to Tip dimension: 5-1/4"</p>	<p>DELTA</p>  <p>SINGLE: DE09H (Surgical, with red & blue dots) (oem RP5645)</p> <p>USED ON: Surgical and kitchen faucets</p> <p>Tip to Tip dimension: 7"</p>
<p>DELTA</p>  <p>SINGLE: DE11H (oem RP42986) for LAV faucets</p>  <p>SINGLE: DE12H (oem RP44476) for KITCHEN faucets</p> <p>These handles are used with this ball.</p> 	<p>DELTA</p>  <p>SINGLE: DE1818 (oem RP2391) for SHOWER valves</p>  <p>SINGLE: DE10H (oem RP2389) for LAV faucets</p> <p>These handles are used with this ball.</p> 	<p>DELTA</p>  <p>SINGLE: DE71 (Lucite ball) (oem H71 / RP2392)</p> <p>USED ON: Shower valves 1300/1400 and Scald-Guard series</p> 
<p>DELTA</p>  <p>SINGLE: DE78H (Lever Canopy) (oem H78)</p>  <p>SINGLE: DE79H (Half Dome Style) (oem H79)</p>  <p>SINGLE: DE71H (Acrylic Ball Style) (oem H79)</p> <p>These three handles are ONLY for use with these cartridges.</p>  	<p>Convert Lucite Handle Delta faucets to Lever Handles</p> <p>Turn this...</p>  <p>...into this:</p>  <p>Use this special conversion ball to convert any Delta Faucet with an acrylic knob to an ADA approved lever handled faucet.</p>  <p>CAT NO: 944B022 OEM: RP20111</p> <div data-bbox="1258 1404 1553 1979"> <p>SHOWER VALVE</p>  <p>ADJUSTING RING HANDLE CAM AND PACKING 4 HOLES (UP) LARGE SINGLE HOLE (DOWN) CAP ASSEMBLY SET SCREW</p> <p>CONVERSION BALL (VIEW FROM BOTTOM OF BALL)</p> <p>4 HOLES - UP FOR TUBSHOWER - BACK FOR LAVATORY</p> <p>LARGE SINGLE HOLE - DOWN FOR TUBSHOWER - FRONT FOR LAVATORY</p> <p>LAVATORY VALVE</p>  <p>HANDLE ADJUSTING RING CAP ASSEMBLY CAM AND PACKING LARGE SINGLE HOLE (FRONT) 4 HOLES (BACK) AERATOR</p> </div>	

